

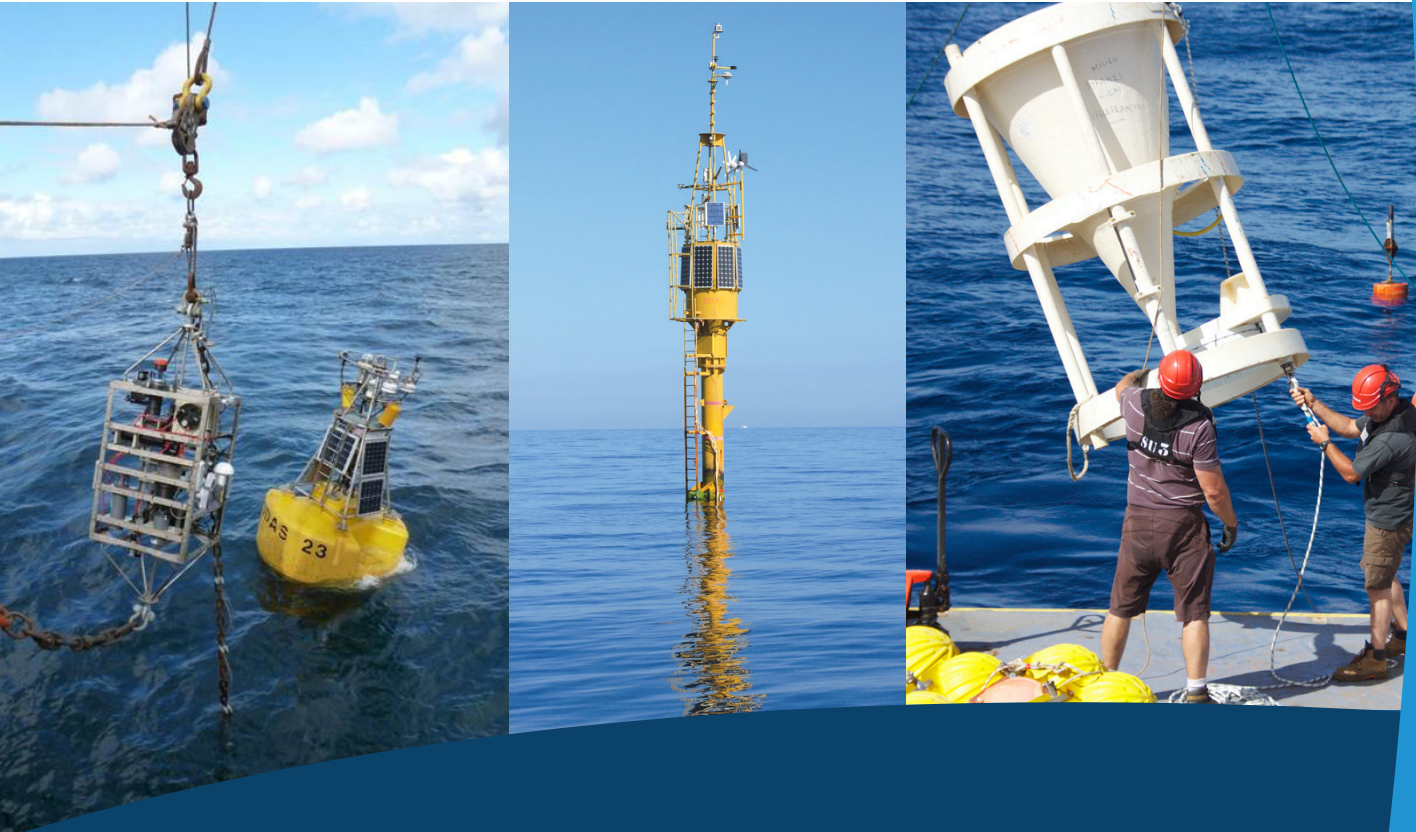

The Fixed point Open Ocean Observatory network (FixO3) seeks to integrate European open ocean fixed point observatories and to improve access to these key installations for the broader community.



# Handbook of best practices

This handbook collects the “best practices” in all phases of the system covering the entire infrastructural chain of data acquisition. It includes recommendations on how to produce high quality data aiming towards common methodologies and protocols within the FixO3 network.

Find out more **Web:** [www.fixO3.eu](http://www.fixO3.eu) **Twitter:** @fixO3Project

FixO3 is a project financed by the European Commission through the 7th Framework Programme for Research, Grant Agreement 312463



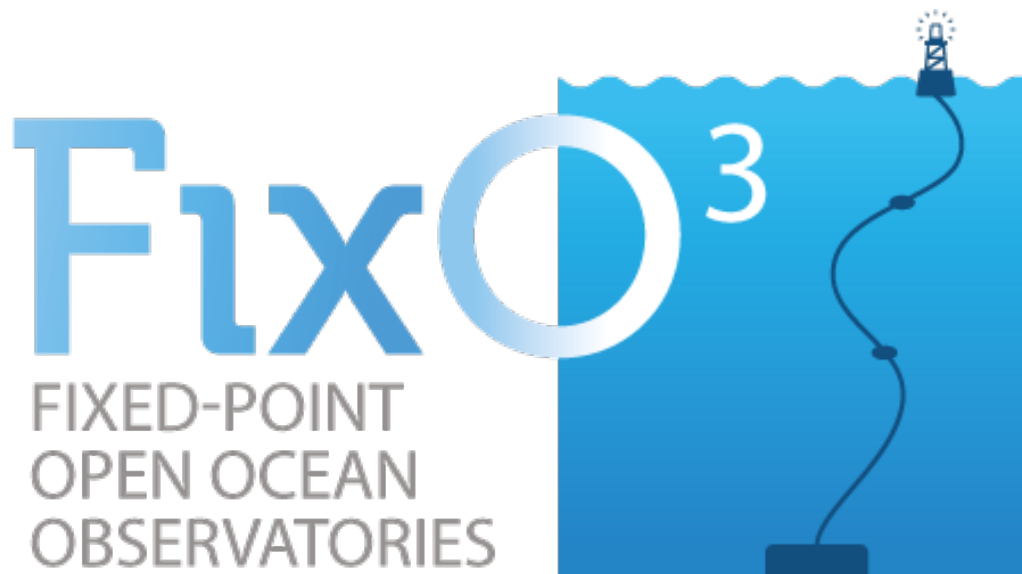

# Handbook of best practices

---

This handbook collects the “best practices” in all phases of the system covering the entire infrastructural chain of data acquisition. It includes recommendations on how to produce high quality data aiming towards common methodologies and protocols within the FixO3 network.

**A work led by:**

L. Coppola, M. Ntoumas, R. Bozzano, M. Bensi, S. Hartman, M. Charcos Llorens, J. Craig

**Contributors:**

JF. Rolin, G. Giovanetti, D. Cano, J. Karstensen, A. Cianca, D. Toma, C. Stasch, S. Pensieri, V. Cardin, A. Tengberg, G. Petihakis, L. Cristini

**June 2016**



This work has received funding from the European Union Seventh Framework Programme under grant agreement n. 312463, FixO3.

## Contents

Executive Summary .....	4
1. Observatories .....	5
1.1 Introduction .....	5
1.2 Platform types (CNR, IFREMER, INGV, IEO).....	5
1.2.1 Mooring lines .....	5
1.2.2 Buoy .....	9
1.2.3 Standalone seabed platforms .....	14
1.2.4 Cabled observatories .....	15
1.2.5 Platform summary .....	16
1.3 Design structure (OGS, GEOMAR, PLOCAN) .....	17
1.3.1 Observing purpose: parameters to measure and sensors selection .....	17
1.3.2 FixO3 geographical location.....	20
1.3.3 Mooring lines/anchoring systems .....	22
1.3.4 Data access during deployment.....	26
1.3.5 Energetic autonomy .....	31
2. Pre-Deployment procedures (NOC, HCMR, CNRS, UPC) .....	33
2.1 Maintenance .....	33
2.1.1 Maintenance on site .....	33
2.1.2 Maintenance on land .....	34
2.1.3 Instrument maintenance.....	35
2.2 Corrosion prevention .....	36
2.3 Biofouling prevention .....	37
2.4 Sensors configuration/Installation .....	38
2.4.1 Observatory payloads .....	38
2.4.2 Sampling scheme.....	39
2.4.3 Sensors validation/calibration .....	40
3. Deployment and recovery (OGS, IFREMER, Univ. Aberdeen, UPC) .....	50
3.1 Means .....	50
3.1.1 Means for mooring and buoys.....	50
3.1.2 Means for seabed observatories.....	52
3.2 Deployment- recovery procedures.....	53
3.2.1 R/V operations .....	54
3.2.2 Tests prior to deployment.....	54
3.2.3 Deployment procedures .....	55

3.2.4 Recovery procedure .....	57
3.3 Inspection/maintenance (servicing) .....	57
3.3.1 ROV operations.....	57
3.3.2 Divers operations .....	58
4. Post-deployment procedures (CNRS, IEO, CNR, INGV) .....	59
4.1 Data transfer .....	59
4.1.1 Real time vs delayed mode .....	60
4.1.2 Data post processing .....	60
4.2 Emergency procedures.....	61
5. Quality control procedures and data correction (CNRS, GEOMAR) .....	61
5.1. Quality control .....	61
5.1.1 Quality flag .....	61
5.1.2 Processing level .....	62
5.2 Data correction .....	63
5.2.1 Oxygen data correction .....	63
5.2.2 Nitrate data correction .....	67
5.2.3 Field data correction of pCO <sub>2</sub> optodes .....	68
5.2.4 Data correction summary .....	70
6. Future directions (Univ. Aberdeen, 52North, UPC) .....	71
6.1 Sensor web enablement .....	71
6.1.1 Sensor web .....	71
6.1.2 SWE information models.....	72
6.1.3 SWE web services .....	73
6.1.4 SWE applications .....	74
6.1.5 Perspectives for ocean observatories .....	74
6.2 Other fields of improvement.....	75
Appendix A. Glossary .....	76
Appendix B. Observatory Instrument Data Sheet .....	111
Appendix C Materials .....	117

## Executive Summary

This handbook describes the principles of “Best Practices” in all phases of the system (pre-deployment test, maintenance, calibration etc.) covering the entire infrastructural chain of data acquisition from sensor (performance, robustness, accuracy, etc.) to supporting system (cabling, electric and electronic components, etc.). As this growing field of marine research gains momentum, many in the community, including representatives of coordinated research projects, international scientific organizations, funding agencies, and scientists felt the need to provide guidelines and standards for operation. This effort has produced recommendations on timing and frequency for sampling, calibration procedures, the latest anti-fouling measures and procedures to combine different data to produce high quality products. The ultimate goal of this effort is to adopt common methodologies and protocols within the network.

# 1. Observatories

## 1.1 Introduction

The “Best Practices” handbook aims to establish optimal ways for users desirous to implement fixed stations in open ocean region. This report is based on FixO3 community experiences and recommendations from previous European projects (ESONET, JERICO). It describes all procedures used within the network, such as maintenance, service, sensors calibration, pre and post deployment operations as well as data transfer and data qualification necessary to operate an open sea observatory.

The FixO3 “Best Practices” handbook will be the backbone for the next FixO3 label which aims to set up a list of rules and recommendations for open ocean fixed observatories (standalone and cabled).

## 1.2 Platform types (CNR, IFREMER, INGV, IEO)

The FixO3 network includes fixed open ocean platforms able to collect in-situ measurements from the upper atmosphere down to the ocean interior and the sea bottom.

Several types of systems can address these issues and the choice about the most suitable platform is related to the physical processes to be investigated, to the environmental constraints of the deployment area and to the expected monitoring period (in the medium or long term).

The following sections present different types of Eulerian systems that can be used in a single site or combined together in arrays to enhance the monitoring capabilities of any desired observatory exploiting the advantages of each system.

### 1.2.1 Mooring lines

Moorings are a series of pieces of in line rope equipped with autonomous oceanographic and biogeochemical sensors. Moorings are anchored on sea-floor and can be used in coastal or off-shore waters, in shallow, intermediate or even deep waters.

The main components of a mooring are:

- anchor, generally constituted of railroad car wheels or a block of heavy material (i.e., iron, concrete, etc.) to be used as ballast. It plays a very important role in the design of the overall mooring since it must be dimensioned to guarantee that the mooring line remains in position counterbalancing the buoyancy but should not too heavy as this would put considerable tension on the wire during the deployment which may even cause the wire to break. The anchor is often lost/remains as at the seafloor after recovery, at least in high seas. Within 200 mile zones some countries request anchors to be recovered (e.g. Norway). This practice should be the rule once observatories become permanent.



Figure 1.2.1 a Deployment of mooring anchor

- pieces of ropes, generally made of synthetic fiber ropes<sup>1</sup>, polypropylene, steel wire or nylon to which sensors are attached in line directly to the cable or by means of clamps. Multiple pieces of ropes are joined together through shackles and rings and/or supported by swivels (to take up torque that may be generated by movement of the ropes in e.g. tidal currents). The rope segment may need a certain termination at the end (e.g. thimble).
- pieces of light and heavy chain, can allow to balance the weight of the overall mooring line, to strengthen some part of the overall design and to give it the desired shape.



Figure 1.2.1 b Chain used as anchor for mooring

- floatation, generally with the shape of a sphere for their low drag coefficient, constituted of synthetic foam or glass covered with plastic “hard top” protection. The floatation provide buoyancy to the construction to balance the weight of the instrument and all other heavier-than-seawater components, and as such holds the rope/wire upward. Floatation is either be added as a piece between segments of mooring line (with shackle/ring connection) or is mounted on the rope/wire (e.g. eddy grip). Adding buoyancy at multiple places/depths on the mooring will ensure that the mooring line spreads out at the surface more wide after release for easy recovery of the equipment.



Figure 1.2.1 c Typical floats used during mooring deployment

- acoustic releaser, a transponder deployed in line with the mooring generally mounted close to the anchor. The release mechanism is activated by sending an acoustic signal, unique for each transponder, by a command unit. Releasers are battery powered hence a safe deployment duration has to be limited to one or two years at the most. To maximize the probability of a successful recover also the use a couple of them joint together in a tandem configuration with a short piece of chain and a ring is recommended. Systems use either a motor that winds a shaft open for release or burn a wire which in turn releases a shaft. Explosive releases have been used in the past but their only reliable versions correspond to navy quality insurance processes leading to high costs.



Figure 1.2.1 d Acoustic releaser

- mooring finder, a device that enables positioning of a mooring. In most cases the mooring finder is used to locate a drifting mooring line. Normally deactivated under water, the mooring finder is activated when the mooring (or parts of it) appear unexpected at the surface. The mooring finder will either allow positioning (e.g. Argos, passive system via triangulation of multiple satellites, less accurate) or sending its position (e.g. GPS/GLONASS based active system that use the satellites to determine the device position and in turn broadcasts this position via communication satellites such as Iridium; high accuracy). Activation of the system is often by light detector or a conductivity cell (low/no conductivity indicate sensor has left the water and is as such at the surface). Unexpected surfacing could be due to the cut of the rope, a failure/corrosion of an element or vandalism.

The choice of the hardware to be used in the mooring, the type of rope and chain, the number and the position of the floats are strictly linked to the monitoring aim, the site depth and the environmental features (i.e., presence of strong currents) of the deployment area.



Moorings can be subdivided into two categories, sub-surface and surface. The first category comprises all instrumented lines that are fully submerged, they are not directly under the impact of surface forcing (except close to the surface), are invisible to ships, and can be the right choice if the aim is to investigate physical properties of sea-water and biogeochemical/biological parameters that do not require to be observed very close to the surface or even at the air/sea interface. Data of subsurface mooring are generally available only after the recovery.

Surface mooring are equipped with a surface buoy that can be used to acquire very near-surface ocean and atmosphere data or/and to transmit data with some kind of telemetry system to ashore. This is the right choice if the objective is to study the meteorological forcing in the first layer of the water column coupled with the analysis of the physical and biogeochemical properties of seawater. In the design of surface moorings, it is necessary to take into account the substantial forces that impact any construction at the sea-surface (waves, atmospheric forcing) and well as the “visibility” of the system to ships. Data can be available in (near) real-time at a receiving station ashore if transmitted to the surface buoy through cables directly connecting each sensor to the acquisition and control electronics on board the buoy, or using inductive cable or acoustic modem.

With respect to other types of platforms, moorings allow to study the entire water column and must be recovered every two years at the most, to be quite sure about the correct functioning of the acoustic releasers.

To deploy and recover moorings, it is usually necessary an equipped ship (i.e., a tug) or a research oceanographic vessel able to manage a heavy ballast and in case of deep mooring also very long cables.

Examples of mooring within the FixO3 network are CIS (surface buoy with GPS locator), Dyfamed, Filcher, FRAM, LION, NOG, SOG, SOR, Station M and Tenatso.

E2M3A, PAP, Pylos and W1M3A observatories are composed of a surface buoy and a close-by sub-surface mooring line (Figure 1.2.1 e).

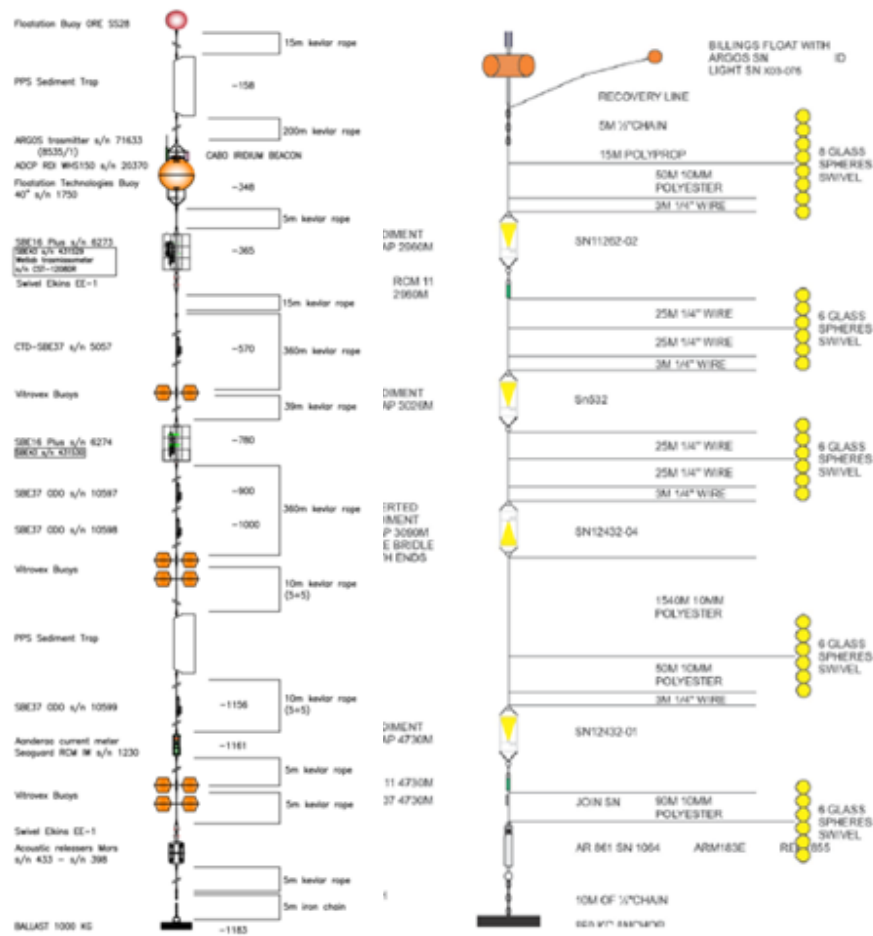

Figure 1.2.1 e: Example of (left) E2M3A and (right) PAP sub-surface mooring design scheme.

## 1.2.2 Buoy

Oceanographic buoys are floating structures anchored to the sea floor and equipped with oceanographic and/or meteorological instruments. They can be used in any coastal or offshore waters.

Buoys system are employed to study air-sea interactions processes, to analyse the first layers of the water column and every time it is necessary to telemeter data ashore.

Design, shape, anchoring modes and types of the buoys depend on scientific purposes, environmental constraints of the area of the deployment and on the availability of means to perform maintenance operations. They follow engineering rules corresponding to the long experience of meteorology and marine navigation or light house buoys. Some of these practices are referred to in the results of a WMO working group<sup>ii</sup>.

Figure 1.2.2 a shows five different mooring types for buoy, from shallower to deeper waters.

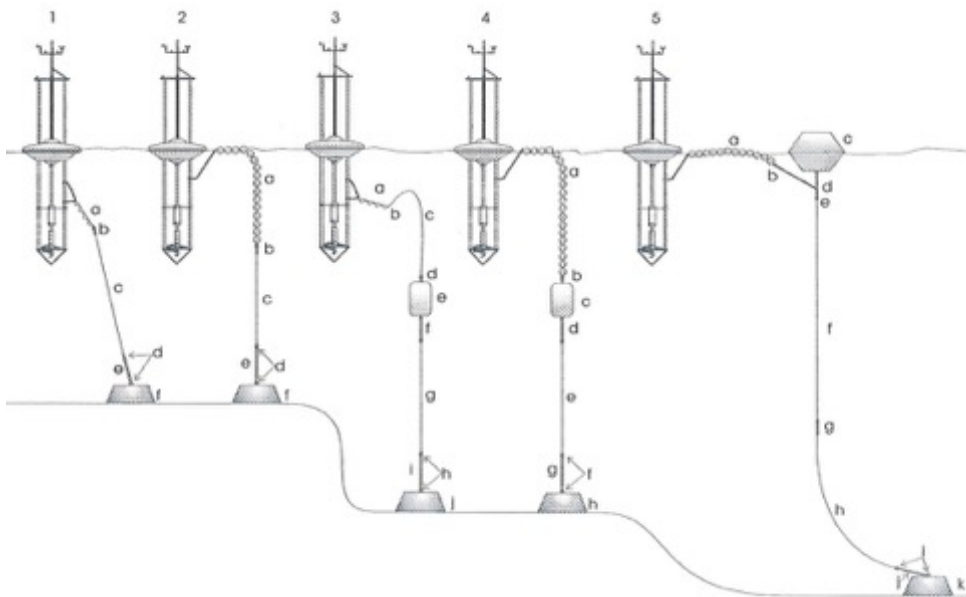

Figure 1.2.2 a: Five different mooring types increasing depth from left to right

The main components of an oceanographic buoy are:

- anchor, that can be a ballast like for a sub-surface mooring or a common anchor for ship, has the role to maintain the buoy in position providing enough holding power and must be chosen considering the type of bottom (sandy, rocky etc.) and the environmental conditions of the deployment area especially for presence of strong winds and currents that impose a relevant stress and high tension to the mooring line and, consequently, high drag also on the anchor.



Figure 1.2.2 b: Typical anchor used for buoy deployment

- hull, whose shape and material characterize the type of the buoy and its peculiar monitoring capability. The hull must be designed in order to guarantee the floatation of the structure and enough space for hosting the electronics needed to acquire/control/process/transmit data, the battery for powering the equipment and also for the scientific instrumentation.

To prevent corrosion of electronic equipment contained within the hull, the hermetically sealed hull is preferably filled with a neutral gas such as nitrogen so as to move the air contained naturally inside, thereby ensuring the absence of water as

vapor in the operation environment. It is a good practice to bring these sealed hulls to a gas pressure lower than one atmosphere, an ancillary pressure sensor is then checking permanently that no leakage changes this internal pressure.

Discus buoys have a circular hull that can be designed in different size and material (aluminium, steel, titanium, polyethylene, polyurethane, syntactic foam glass or carbon epoxy composite). Small discus buoys are really suitable to measure sea waves characteristics, whereas large discus buoys can host a trellis to acquire meteorological parameters. Design principles of a large discus buoy are comparable to those of a small ship concerning safety conditions (compartments for water invasion, stability, electrical safety, thunder safety,...).<sup>iii</sup>

The hull of a spar buoy is constituted of a long pole made of steel or aluminium and of a floatation element. Its structure is not so affected by waves as discus buoys and on its top is possible to install meteorological instruments and a small laboratory. To be efficient spar buoy cannot have much reserve buoyancy.

- mooring line, that can be instrumented or not, must be designed to have a sufficiently high breaking load to compensate the stress due to the drag of the structure due in turn to the forcing of wind, waves and current. If the buoy has to measure wave parameters, an extra mooring line length is needed (up to a reasonable limit) in order not to restrain its moves and thus alter the measurements. Extreme values of the tidal range of the site must be taken into account for the mooring line design.



Figure 1.2.2 c: Synthetic mooring line

- autonomous power supply system, that can be constituted of solar panels and/or wind turbine recharging on-board batteries and has to guarantee enough power to the overall equipment (scientific and service) and to the electronics (i.e., datalogger, communication by acoustics and satellite). An independent power system is needed for the position light and safety mandatory equipment.

Figure 1.2.2 d shows a complete deep water buoy mooring and buoy detail for IEO Biscay AGL

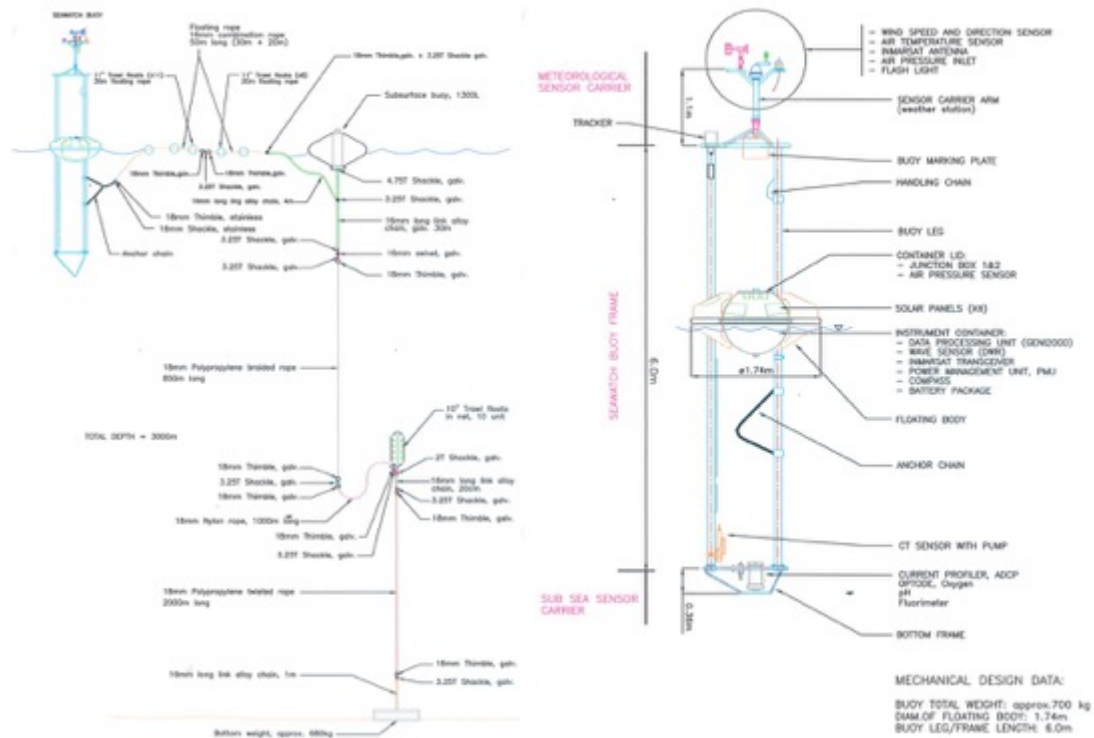

Figure 1.2.2 d: A deep water buoy mooring design (left) and buoy design with instruments (right).

Eulerian buoys can be subdivided in two main categories: single point or multi-leg moored platforms. The single point moored buoys are characterized by the presence of one single mooring line, that can be instrumented or not and has the role to maintain in position the structure both in case of a vertical or a slack mooring design.

Platforms of this type can be spar or discus buoys: spar buoys have a small buoyancy to drag ratio, their motion due to sea waves can be negligible and for this reason they are suitable to measure with reliability atmospheric parameters also in rough sea. On the contrary, discus buoy has a large buoyancy to drag ratio and their motion follow wave dynamics, hence they are really suitable for wave measurements but less effective for meteorological observations.

Both spar and discus buoys can be used as unmanned platform.

Multi-leg buoys are characterized by several anchoring points and are used especially as manned laboratory. The multi-leg structures compared to the single point anchored platform show more stability, can host on their top a large laboratory and a living quarter and have the capability to support studies of small scale phenomena exploiting the ability to install close spacing sensors on mooring legs.

Eulerian buoys are the most suitable choice if the objective is the long term monitoring, since they can stay at sea several years without need of maintenance to the structure. Data can be stored on board or transmitted in near time and the scientific payload can include meteorological as well as oceanographic and bio-geo-chemical sensors. Buoys can host also sensor with considerable dimension and even power consuming if the power supplied by the system is enough and the shape of the buoy allows it.

In order to make the buoy visible to ships and sailor, it must be equipped with a lamp and a radar reflector following the rules of the area of deployment (e.g. IALA recommendation).

The major problem of buoys is related to the corrosion and the colonization by marine fauna of the structure. Corrosion affects the metallic component of the buoy and in order to limit the deterioration of the structure the most common solutions are (i) antifouling and protective paint and (ii) small blocks of sacrificial anodes clamped and electrically connected to the structure. Often pieces of sacrificial anodes for corrosion protection and copper foils for anti-fouling are used to protect the underwater sensor installed on the buoy according to the principles of galvanic isolation between sub-systems (see Appendix C Materials).

To deploy and recover buoys, it is necessary a large ship or research vessel and sometimes, depending from the dimension, a tug and divers.

Maintenance to scientific equipment has to be performed at least twice a year, especially for the oceanographic and bio-geo-chemical sensors (the latter may require more frequent maintenance depending on the mooring position), whereas the overall structure can remain at sea several years before the need to be recovered, but in case of strong stress on the mooring line, it is necessary to inspect all parts of the mooring line (shackles, swivels, chain, etc.) once every 3 years at least.

FixO3 network comprises several single point discus buoys, nominally BISCAY, E1M3A, E2M3A, ESTOC, MOMAR, PAP, PYLOS and only one spar buoy the W1M3A system (Figure 1.2.2 e).

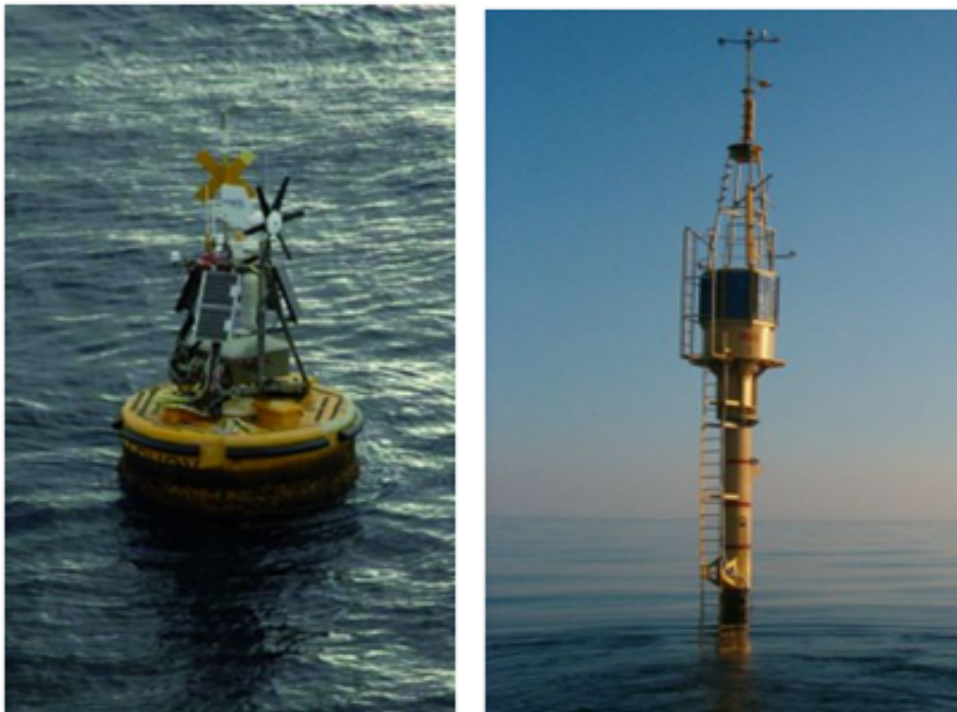

Figure 1.2.2 e: (left) The ESTOC discus buoy and (right) the spar buoy of the W1M3A observatory.

### 1.2.3 Standalone seabed platforms

Standalone seabed platforms are structures positioned on the bottom used for acquiring uninterrupted high resolution seabed observations needed for marine geosciences interested in physical phenomena occurring at the seafloor (e.g., seismic waves, gas seepage, etc.) as well as biological observations occurring over long time periods, ; they are equipped with oceanographic sensors, their structure may vary from grouped single instruments to huge networks of multi-parametric observatories and can be deployed in coastal or offshore waters.

The components of a stand-alone seabed platforms differ from the design of the platform and its dimension, but the main parts are constituted of:

- frame that can vary in material and shape and hosts the scientific equipment. If the deployment area is characterized by intense fishing activities the frame has to be trawl-resistant to avoid accidents.
- transmission to the sea surface
- battery pack that has to guarantee enough power to the instrumentations on an annual basis. Power consumption is a critical issue and this must be kept in mind when choosing the components of such a platform
- electronic Front-end that collects data from the instruments, distribute the energy and store/transmits data

They are deployed by a cable from a ship able to ensure precise positioning. The deployment requires a ship and an ROV. The precise positioning (decimetric) and orientation is necessary to ensure the constitution of time series over several operating periods.

As an option, the free falling mode may be used provided an ROV is able to position the platform at the right place. Then the recovery does not need an ROV thanks to the float/releaser system. It involves additional components:

- floats made of syntactic foam
- ballast that should be dimensioned in order to prevent dragging on the floor of the entire platform and to provide an adequate mechanical coupling with the ground for instruments that need it, such as seismometers.
- releaser mechanically or acoustically driven. Redundancy is desirable on release systems to prevent any failure. Mechanical release suffers from fouling (fouling may be prevented by moving regularly rotating parts, but this have an impact on power consumption). “Burn wire” release systems are preferred for one of the redundant release when fouling is an issue.
- Floating systems can release the ballast and float up to the surface. This can happen at a scheduled time, or upon request from the surface (acoustic release).

Heavy enough stand-alone systems can be recovered using acoustic pop-up systems: an acoustic release unhook a float that brings to the surface a wire. The vessel uses this wire to recover the system. The wire must be strong enough to carry the weight of the entire observatory in water, so the depth of deployment of these systems is limited to a reasonable length of the wire (typically some hundreds of meters). For big systems at higher depths an active intervention (by ROV or other similar systems) is needed to hook the platform to the heavy load line of the vessel.

To extend the spatial coverage of the FixO3 observatories, it might be useful to use lander systems for one deployment. They are not positioned precisely and do not communicate

their data to other platforms. For example, Ocean Bottom Seismometers (OBS) can be easily launched from a small vessel and flop down to the seabed whereas bigger or more delicate systems may need to be laid down gently from the vessel and require the use of a release system.

In the most favourable configuration, seabed platforms are coupled to a buoy: the platform communicates with the buoy with acoustic or inductive modem and the buoy provides a radio (satellite) data link with the shore. In these cases, real-time communication of data or events is possible, but constraints about modem link bandwidth and power budget are still valid. Precise clock synchronization is required for any scientific use of data recording. Needed precision varies over several magnitude orders for the different phenomena and disciplines. In some cases, the internal clock of sensors can be enough, while in other it is necessary to design a system with a more precise quartz clock compensated in temperature. WP12 of FixO3 proposes an atomic clock for the stand alone observatory design.

Within FixO3 network MOMAR, OBSEA and DELOS observatories include a seabed platform (Figure 1.2.3 a).

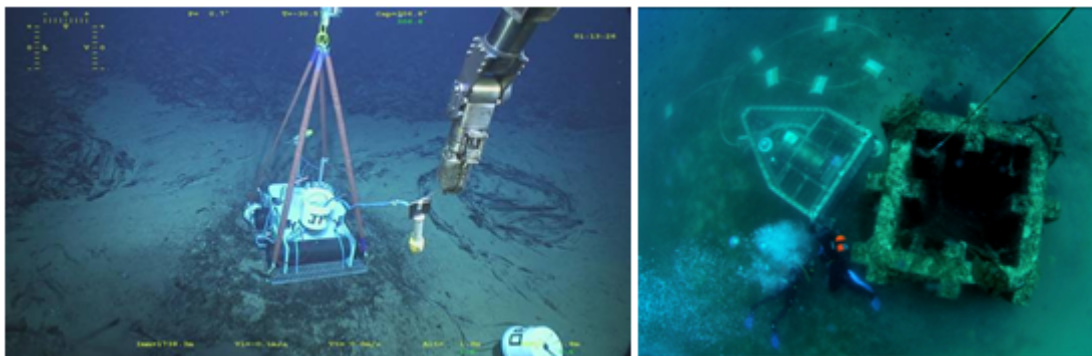

Figure 1.2.3 a: Positioning and maintenance of (left) MOMAR and (right) OBSEA seabed platforms.

#### 1.2.4 Cabled observatories

Cabled observatories are generally seabed platforms connected ashore by means of a cable. They are devoted to monitor long term ocean phenomena and unexpected events; they are characterized by a high bandwidth communication that makes data directly available in near real time. Cabled observatories can be used both in coastal and deep water. They may have also sub-surface mooring deployed close-by and connected to the cable to shore through a junction box. This latter element is one of the critical component of the cabled observatory since it allows multiple instruments or devices to be multiplexed to the cable to shore.

The main components of a cabled observatory are:

- structure that can vary in material and shape and must be designed to house and protect the equipment from external factors. The structure has also to withstand both the traction of the marine cable generated by the water currents and the water pressure.

The structure has to provide the interface between the marine cable and the instruments connected to the observatory.



- marine cable that is a telecommunication cable used to link the platform to the land station and to provide continuous transmission of data and supply of power. Commonly, for platforms placed at a big distance from shore station, optical fibers are used.

Cabled seafloor platforms overcome many of the constraints of stand-alone systems. In fact, they have unlimited power budget, real time communication, synchronized clock, virtually unlimited storage size and, moreover, they allow to use data for civil protection purposes.

The deployment of the infrastructure is requiring specialized engineering skills (cable ship, ROVs, high voltage shore stations, fiber optic multiplexing...) and contracting (legal and impact issues).

On the contrary cabled platforms can't be relocated and require ROVs (in shallow water, scuba divers) to connect the platform that has to be placed in the right position with respect to the underwater cable termination. The maintenance and extension operations are more similar to other types of platforms.

High bandwidth communication and power are the main reason for choosing a cabled platform. Dedicated communication hardware is needed, but in most of the cases it's possible to base on existing technologies, since requirements are not too different from the standards of telecommunications industry. Cabled platforms can solve the clock drift problem by a GPS antenna placed onshore. GPS timing signal can be distributed to the seabed platform directly or via network synchronization protocols (NTP, PTP according to the precision needed).

FixO3 cabled observatories are ANTARES and NEMO SN1 (Figure 1.2.4 a).

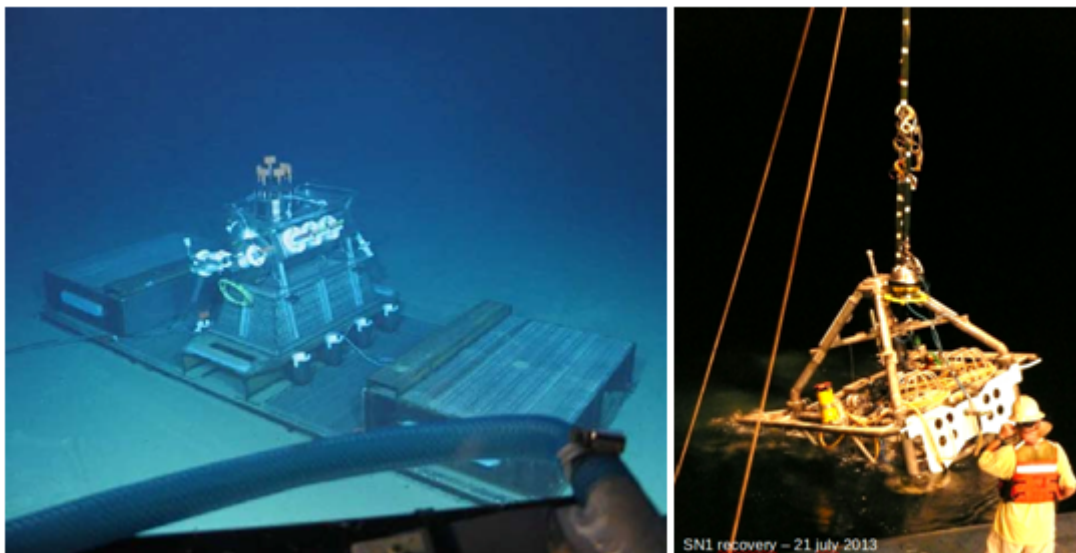

Figure 1.2.4 a: Deployment of (left) ANTARES and (right) recovery of NEMO SN1 seabed platforms.

### 1.2.5 Platform summary

The following table summarizes the characteristics of each type of platform in terms of typical deployment duration, scientific payload, means needed for deployment, main structural components and example of processes that can be investigated with.

Table 1.2.5 Platforms characteristics used in the FIXO3 network

	Deployment Duration	Main disciplines	Means for Deployment	Main Components	Investigated Processes
<b>Mooring</b>	yearly/ multiannual	oceanographic/ biogeochemical	large ship / research vessel	anchor/ ropes/ chain/ floats/ acoustic releaser/ Argo beacon	water column physical and biogeochemical properties
<b>Buoy</b>	multiannual	meteorological/ oceanographic/  bio-geo- chemical	large ship/ research vessel/ tug/  divers	anchor/ hull/ mooring line / autonomous power supply	air-sea interaction/ physical and biogeochemical properties of the ocean surface layers
<b>Seabed stand alone</b>	Yearly/multi annual	geophysical / oceanographic / biological	Small vessel/  large ship/  ROV	frame /  battery pack	seismic waves/  gas seepage/  biological obs.
<b>Cabled</b>	multiannual	Multidisciplinary geophysical /  oceanographic	small vessel /large ship/  ROV /divers	structure / marine cable	seismic waves /  gas seepage

## 1.3 Design structure (OGS, GEOMAR, PLOCAN)

### 1.3.1 Observing purpose: parameters to measure and sensors selection

Meteorological and oceanic time-series observations are fundamental to progress in the understanding of climate. The Global Climate Observing System (GCOS) program developed the concept of “essential climate variables” (ECVs), which has been broadly adopted in scientific proposals and political discussions. The datasets collected should be traceable to quality standards and cover sufficiently long periods (for example, the 30 years traditionally used for calculating climate normal). Therefore, the selection of the variables and the sensors that measure them is fundamental in order to obtain good quality data which can be used in global contexts.

Bojinsky et al. (2014) define the ECV as “a physical, chemical, or biological variable or a group of linked variables that critically contributes to the characterization of Earth’s climate. The list of ECVs is specified in GCOS (2010) and the last update on December 2014 is found in <http://gosc.org/ios/MATRICES/ECV/ECV-matrix.htm>. This list split the variables distribution in three categories: Atmospheric (over land, Sea and Ice), Oceanic and Terrestrial. FixO<sup>3</sup> observatories focus their observations on atmospheric over sea, oceanic and geophysical (geohazard, fluid fluxes and seismology). Among the oceanic variables we can distinguish three different levels of observation: surface, sub-surface or water column and the sea-floor.

### 1.3.1.1 Core parameters

The core of atmospheric variables to be measured are widely known. These variables are difficult to be measured from oceanic buoys. Hence, most of these real time observations from the oceans came from the opportunity ships which operate at specific marine routes. However, the combination of atmospheric and oceanic observations results essential to progress in the knowledge of the ocean-atmosphere interaction. Among the main variables to consider we can distinguish pressure, temperature, humidity, wind speed and direction, radiation budget and precipitation. **Surface air pressure** measurements help to investigate about atmospheric circulation patterns in the climate system. Long-term air pressure data compilations can be used to assess changes, fluctuations and extremes in climatic circulation regimes. **Surface air temperature** is considered to be the principal variable for determining the state of the climate system. Measures of **surface humidity** over the ocean help to determine the latent heat flux, a major term in the energy exchange between the atmosphere and ocean. **The surface wind field** is the primary driver of the ocean circulation, which transports important amounts of heat, freshwater and carbon globally. It is a sensitive measure of the state of the global coupled climate system and is very valuable for climate change detection and climate model evaluation. **The surface radiation budget (SRB)** is a fundamental component of the surface energy budget that is crucial to nearly all aspects of climate and needs to be monitored systematically. There is a large set of weather proven quality sensors manufacturers such as Vaisala, Davis Instruments, Young, Campbell Scientific, etc.

Among the main surface oceanic variables to be measured at the FixO3 observatories we can distinguish the sea surface temperature, sea surface salinity, current, the carbon dioxide partial pressure, pH and phytoplankton. Sea surface temperature and sea surface salinity play an important role in determining the stability of the water column in the mid to high latitude oceans. The ocean density distribution (the distribution of temperature and salinity) determines ocean currents. There are different probes combinations and manufacturers which include temperature and conductivity (salinity) sensors. Here, we are naming those manufacturers whose probes are more used, for instance Seabird electronics, Idronaut, Aanderaa data Instruments, Sea-Sun technology and RBR. Current, the term 'surface circulation' is taken as referring to observations within the ocean mixed layer (ML), which typically extends up to 100m below the surface. Based on the ADCP technique (Acoustic Doppler Current Profile) is possible to measure in a single point or a layer of the water column. There are several manufacturers who offer proven quality probes such as Nortek, Aanderaa and RDI. The surface ocean partial pressure of CO<sub>2</sub>, pCO<sub>2</sub>, is a critical parameter of the oceanic inorganic carbon system because it determines the magnitude and direction of the exchange of CO<sub>2</sub> between the ocean and atmosphere, and as consequence that is a good indicator for changes in the upper ocean carbon cycle. The sensors more used come from the manufacturers such as Pro-Oceanus, Contros, Aanderaa, Sunburst, and SubCtech. The pH is used to measure the ocean acidification due to the uptake of carbon dioxide from the atmosphere. In order to fully characterize the chemical state of the inorganic carbon system in the surface ocean, a second property, in addition to pCO<sub>2</sub>, needs to be measured, i.e., either dissolved inorganic carbon (DIC), alkalinity (Alk – a measure of the content of carbonate or bicarbonate), or pH. The number of manufacturers for this sensor is short, thus the principals are Satlantic, Sunburst, Sensorlab and Idronaut. Finally, Phytoplankton and primary productivity are key parameters related to both the ocean carbon cycle (including the biological carbon pump) and upper ocean radiant heating rates. To determine these variables from sensor data different approaches can be used based on measurements of measures pigment concentration (usually Chlorophyll a) through fluorometers. The main manufacturers to provide ocean fluorometers are Wetlabs, Turner Instruments, Chelsea and Seapoint.

The subsurface core variables to be measured at the FixO3 observatories includes variables mentioned for the surface core such as temperature, salinity current and phytoplankton, in addition to other variables such as nutrients (usually nitrate) and dissolved oxygen. Nutrient measurements are essential biogeochemical information, and provide critical links between physical climate variability and ecosystem variability. Manufacturers for this kind of sensor are Satlantic, EnviroTech or TriOS optical sensors. Dissolved oxygen is an excellent tracer for ocean circulation and ocean biogeochemistry. The main current manufacturers are Seabird electronics and Aanderaa.

The seafloor core variables to be measured should be those already defined in the deliverable D68 in the ESONET European Seas Observatory Network project ([http://wwz.ifremer.fr/esonet\\_emso/content/download/42247/574588/file/Deliverable\\_D68\\_esonet-label-definition\\_1.0.pdf](http://wwz.ifremer.fr/esonet_emso/content/download/42247/574588/file/Deliverable_D68_esonet-label-definition_1.0.pdf)) where in the table 1 page 18 suggests the variables and the specific characteristics of the sensors. These “generic” variables are conductivity (salinity), temperature, pressure, dissolved oxygen, turbidity, current and passive acoustic.

The list of “specific” instruments in this document is of a very high importance as it provides the multidisciplinary time series collection essential to FixO3 objectives.

### **1.3.1.2 Other parameters**

Among other variables to be included, we can consider the sea state (swell period and height or wave direction and significant height), sound and light, in addition to photosynthetically active radiation and precipitation. Observations of sea state are particularly relevant because affect the air-sea exchanges and can also provide complementary information of relevance to monitoring changes in the marine environment. In mid-latitudes wave height is an indicator of storm track and strength. The distribution of long period swell also reflects the maximum wind speed (fetch and duration) in the generating storms. Changes in wave climate reflect changes in the atmospheric circulation. Waves also play a dynamic role in the climate system, influencing air-sea interaction, albedo and mass exchange across the air-sea interface. The sound is used to obtain information from the ocean interior (bathymetry, fishery, tomography, etc....) but also for the sea surface (acoustic rain detection). The penetration depth of shortwave radiation is of interest to biologists and related to the photosynthetic activity of phytoplankton and algae and links to behavior of zooplankton and fish. The Absorbed Photosynthetically Active Radiation (PAR) refers to the fraction of the incoming Photosynthetically Active Radiation (PAR) that is effectively used in photosynthesis. PAR is a primary variable controlling the photosynthetic activity of phytoplankton. PAR varies in space and time due to differences in species and ecosystems, weather and climate processes.

The above mentioned “specific” ESONET-EMSO parameters are measured by sets of instruments (“modules”). (updated from Ruhl et al. 2011).

Specific modules can be set up in varying combinations according to site-specific objectives. For example, measuring synchronously seismic motion, gravity, magnetism, seafloor deformation (acoustic geodesy), sedimentation, pore-water properties, gas hydrates, and fluid dynamics will provide a great opportunity to make advancements in geosciences and geo-hazard early-warning capability. Specific observatory applications in physical and biogeochemical oceanography require full water depth moorings that allow recording of long-term, high resolution time-series of hydrography, current and biogeochemical state variables (oxygen, fluorescence, nutrients) throughout the water column. A suite of biogeochemical and physical sensors mounted on moored profilers can allow for high-resolution vertical profiling in the upper part of the water column. Instrumentation for particularly extreme conditions are needed for some applications such as hydrothermal vent

research including Mn, Fe, sulfur analysis. Systems for more specialized biogeochemical research include sedimentation trap systems, pigment and hydrocarbon fluorescence sensors, and in situ mass or Raman spectrometry. Observatory systems addressing aspects of marine ecology include those for deep-biosphere monitoring time-lapse and video imaging, active acoustics, plankton sampling and imaging, in situ respiration, and in situ molecular and genetic analysis. Acoustic systems, which use advanced signal processing, are capable of not only acoustic tomography and sourcelocalization, but also recognition of shapes in water.

### 1.3.2 FixO3 geographical location

FixO3 observatories are located in the Atlantic Ocean, in the Mediterranean Sea and in the Artic/Antarctic regions (Figure 1.3.2 a). They span from shallow infrastructure (e.g. OBSEA located at 20m depth and few kilometers from land), to deep sites (such as FRAM and SOG with depth > 5000m), and located at hundreds kilometers from land, (Table 1.3.2 a). The network includes seafloor, mid-water and surface infrastructures. All of the FixO3 observatories have different scientific objectives due to the characteristics of their location. Some of them are devoted to investigating deep or intermediate convection phenomena (e.g. CIS, E2-M3A, E1-M3A, LION, FILCHNER RONNE, LION), others to monitoring water masses interactions (e.g. W1-M3A, ESTOC, FRAM, NEMO-SN1, PAP) or deep-ocean animal community and biomass production (e.g. DELOS, DYFAMED). Observatories such as TENATSO, located off the Cape Verde Islands, are devoted to collect data useful for climate and greenhouse gas studies and for investigating dust impacts on marine ecosystems. MOMAR on the north Atlantic ridge was deployed with the purpose of studying fauna, fluid chemistry, seismicity and ground deformation. Finally, all of them, but in particular the OBSEA observatory (the most coastal site within the FixO3 network), have good infrastructures for testing new instruments. The shortlist of parameters collected in the network ranges from physical to biogeochemical data.

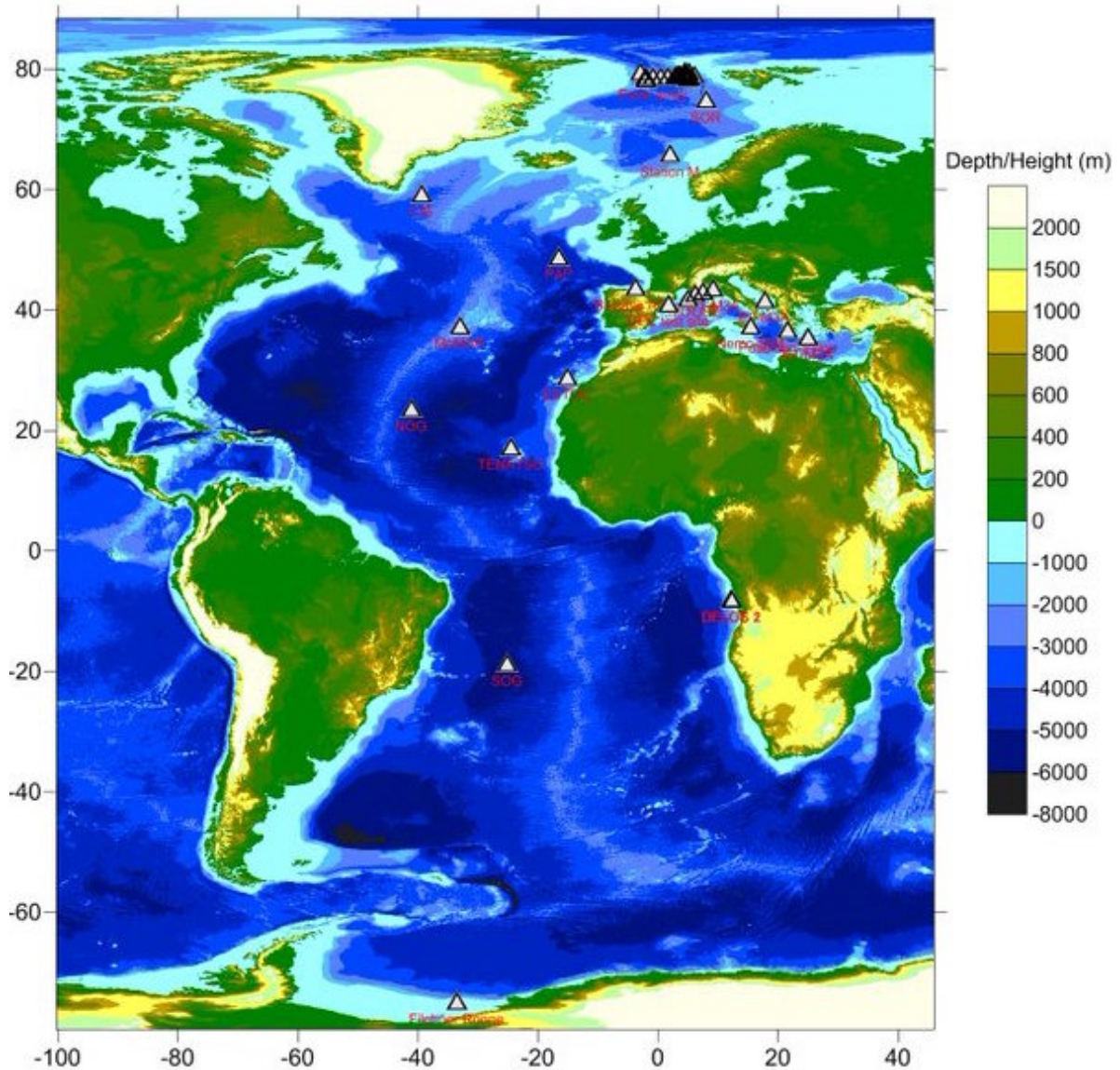

Figure 1.3.2 a: FixO<sup>3</sup> Observatories.

Table 1.3.2.a - Summary of the FixO3 Observatories technical characteristics

Name	Observatory type	Number of instruments	Distance from land (km)	Max. Water depth (m)
<b>Antares</b>	Multiple Arrays, cabled	17	42	2475
<b>Biscay AGL</b>	Single Array	9	41	2900
<b>CIS</b>	Single Array	20	200	3000
<b>DELOS A</b>	Multiple Arrays	11	100	1400
<b>DELOS B</b>	Multiple Arrays	12	90	1400
<b>Dyfamed</b>	Multiple arrays	12	50	2350

Name	Observatory type	Number of instruments	Distance from land (km)	Max. Water depth (m)
E1-M3A	Multiple arrays, cabled	20	46	1440
E2-M3A	Multiple array, gliders	14	100	1220
ESTOC	Single array, gliders	19	97	3615
Filchner Ronne	Multiple arrays	4	200	618
FRAM	Multiple arrays, gliders	100	150	5500
LION	Multiple Arrays	25	135	2400
MoMAR	Multiple arrays, stand alone	3 nodes	n/a	1700
NEMO-SNI	Cabled	13	25	2036
NOG	Single array	3	1000	4235
OBSEA	Cabled	16	4	20
PAP	Multiple arrays	26	200	4850
Pylos	Single array	14	18	1670
SOG	Single array	3	1500	5300
SOR	n/a	n/a	n/a	n/a
Station M	Single array	7	n/a	2000
Tenatso	Multiple arrays	30	110	3603
W1-M3A	Multiple arrays	25	80	1200

### 1.3.3 Mooring lines/anchoring systems

#### 1.3.3.1 Mooring line components – materials

##### Mooring chains

One of the most common components used in all the different types of mooring lines are chains. In most cases the chain will be placed in the upper or/and lower part of the mooring line. There are two general types of chain; the stud link chain and the stud-less chain. A variety of chain dimensions, with different breaking loads, is available for all the types of mooring lines. The main advantage of the stud link chain is that the stud geometry prevents the chain to entangle. However, the stud in the chain has a negative effect on the fatigue life of the mooring line. Therefore, stud-less chains are more commonly used in open sea mooring systems.

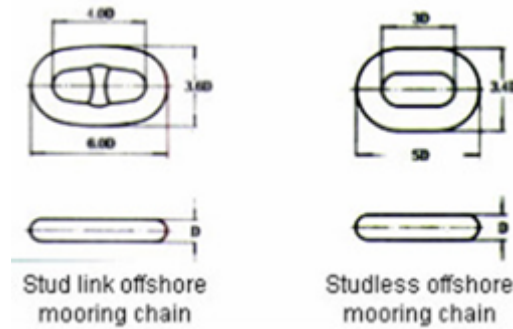

Figure 1.3.3.1 a: Stud link chain type (left) and stud-less chain type (right).

### Steel wire mooring ropes

Steel wire ropes are constructed from multiple steel wires wound in spiral strands or in a wire rope. This can be done in different configurations. The most commonly used wire ropes are six strand and spiral strand. Steel wire ropes have the advantage of a lower weight comparing to a chain with the same braking load but consider being more sensitive to corrosion. Special attention in use of a steel wire rope should be given on the termination of the rope and the connection to the rest of the mooring components.

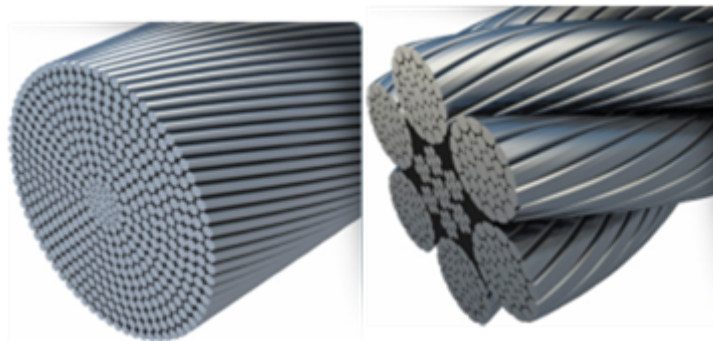

Figure 1.3.3.1 b: Spiral strand (left) and six strand type (right) wire mooring ropes.

### Synthetic mooring ropes

Different types of commercially available synthetic ropes that can be used as a part of a mooring line. The rope material and construction determines the behaviour and the primary characteristics of the rope such breaking load, elasticity, buoyancy life, and abrasion. Pending of the overall design of the mooring line more than one type of rope can be used in in different sections of the line. The table below summarizes the main material based characteristics of different ropes. (*JERICO-D4.4 Report on best practice in conducting operations and maintaining*).



Table 1.3.3.1 a Cable components comparison

	Advantages	Disadvantages
<b>Nylon (PA6)</b>	Most widely used, excellent strength-to-weight ratio, very elastic, easy to splice, excellent shock absorption capabilities, cyclic loading performance, low cost	Shrinkage and loss of strength in seawater, internal abrasion
<b>Polyester</b>	Excellent all-around abilities, does not experience loss of strength in seawater	High cost, limited availability, less elastic than nylon, heavier than nylon
<b>Polypropylene (PP)</b>	Most widely used in combination with buoyant rope, relatively inexpensive, moderately strong, stronger wet than dry, good energy absorption capabilities, resistance to abrasion	Slippery→Extra care, deterioration in sunlight. Dark-coloured ropes are not as susceptible to UV light damage, recommended over lighter-coloured ropes
<b>Polyethylene</b>	Similar to polypropylene but not as strong or buoyant, inexpensive	Used in non-critical applications where buoyancy is needed
<b>Stretched hoses<sup>IV</sup></b>	May adapt the stiffness of the line with damping according to severe cases.	Costly and needing frequent exchange.

The comparison between these cable and chain solutions is still a topic of R&D, with permanent increase of performances.

Table 1.3.3.1 b Selected properties of several synthetic fiber materials, steel and the natural fiber hemp are included for reference [1]

Material	Density (g/cm <sup>3</sup> )	Melting /charring point (°C)	Moisture (%) <sup>6</sup>	Modulus (N/tex, GPa)	Tenacity (mN/tex)	Strength (MPa)	Break extension (%)
Hemp	1.5	~150	8	21.7, 32.6	470	705	1.8
Steel	7.85	1600	0	20, 160	330	2600	2 <sup>(9)</sup>
HMPE	0.97	150	0	100, 100	3500	3400	3.5
Aramid	1.45	500	1-7	60, 90	2000	2900	3.5
PET	1.38	258	<1	11, 15	820	1130	12
PP	0.91	165	0	7, 6	620	560	20
PA6 <sup>(7)</sup>	1.14	218	5	7 <sup>(6)</sup> , 8 <sup>(8)</sup>	840 <sup>(6)</sup>	960	20

Table 1.3.3.1 c Indicative properties of several synthetic rope materials, classified by colour as poor, average and good, and actual performance will depend on the rope construction and application. [1]

Material	Ductility	Strength (Wet/Dry)	Resistance				
			UV	Temperature	Abrasion <sup>10</sup>	Creep	Tension/compression fatigue
HMPE	Red	Green, Green	Yellow	Red	Green	Red	Green, Green
Aramid	Red	Green, Green	Yellow	Yellow	Yellow	Green	Green, Red
PET	Yellow	Green, Green	Green	Green	Green	Green	Green, Green
PP	Yellow	Red, Red	Red	Red	Yellow	Red	Red, Red
PA6	Green	Green, Yellow	Green	Green	Yellow	Yellow	Green, Green
LCP	Red	Green, Green	Red	Yellow	Yellow	Green	Green, Green

### 1.3.3.2 Mooring line anchoring systems

The anchoring system of an oceanographic mooring line usually consists of the anchoring ballast and an acoustic releaser attached at a safe distance from the ballast in order to avoid any damage during the deployment of the line. The ballast can be an ordinary ship anchor, a reinforced concrete or iron block, railway wheels and sometimes large chains. The safe anchor mass should be determined taking account the overall positive buoyancy of the mooring line, the type of the seafloor and the environmental conditions of the deployment site. In some cases, where strong winds (surface) or strong currents are presence a secondary smaller anchor can be used to increase the drag resistance of the anchoring system.

### 1.3.3.3 Mooring design software

Mooring lines must be designed according to static and dynamic behaviour predicted by a software model for the extreme storm conditions and the fatigue cycles (frequency domain at list if linear behaviour). Such software are proposed by software engineering companies for instance Orcaflex by Orcina Ltd.<sup>v</sup> The risk of more complex behaviour such as Vortex Induced Vibrations may be estimated by hydrodynamic specialists from their experience or from experiment in towing tank.

A useful tool to design and evaluate mooring lines for oceanographic observatories is the MATLAB toolbox *Mooring Design and Dynamics*. This set of routines developed by Richard K. Dewey is freeware license software that allows the user to build his own libraries of materials in order to design a customized mooring line. The package can be used to design and evaluate single point surface, including S-shaped moorings, and sub-surface moorings lines by placing all the components of the line in the appropriate order through the graphic user interface. The tension and the shape of the mooring line under the influence of wind and currents, and the simulation of mooring component positions when forced by time-dependent currents can be simulated. The static model will predict, apart from the tension and tilt of each component, the anchor safe mass to be used. The recommended mass of the anchor can be different taking under consideration the choice of the anchor material e.g., steel or concrete. The solution is calculated by solving a set of force balance equations under the influence of time dependent 3 dimensional currents. The user can define the current velocity direction and perform evaluation for different scenarios. Here is illustrated the solution provided by *Mooring Design and Dynamics* for a 1400 meters long submerged mooring line hosting 2 sediment traps in the E1M3A observatory (Cretan sea). The first graph shows the behaviour of the mooring line under the mean current velocities and the second graph is the line behaviour under the maximum current velocities. For both cases the safe anchor mass has been calculated.

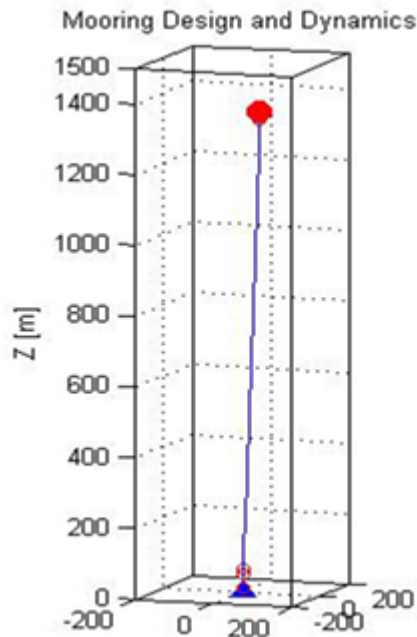

*This is a sub-surface solution.*

*Total Tension on Anchor [kg] = 335.5*

*Vertical load [kg] = 335.4 Horizontal load [kg] = 7.7*

*Safe wet anchor mass = 522.3 [kg] = 1149.1 [lb]*

*Safe dry steel anchor mass = 600.4 [kg] = 1320.8 [lb]*

*Safe dry concrete anchor mass = 803.6 [kg] = 1767.9 [lb]*

*Weight under anchor = -229.5 [kg] (negative is down)*

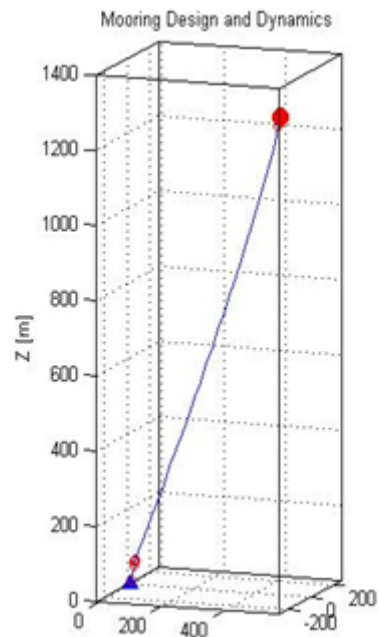

*This is a sub-surface solution.*

*Total Tension on Anchor [kg] = 333.2*

*Vertical load [kg] = 323.1 Horizontal load [kg] = 81.3*

*Safe wet anchor mass = 687.9 [kg] = 1513.4 [lb]*

*Safe dry steel anchor mass = 790.7 [kg] = 1739.5 [lb]*

*Safe dry concrete anchor mass = 1058.3 [kg] = 2328.3 [lb]*

*Weight under anchor = -231.9 [kg] (negative is down)*

*Figure 1.3.3.3 a: The mooring lines under the influence of the currents mean velocity will develop a slope of 11° (left) while the currents maximum velocity (right) will cause a slope of 32°.*

### 1.3.4 Data access during deployment

Access to data from observatory instruments during deployment is needed in a FixO3 context to (1) verify the sensor functioning, (2) download/backup the data recordings for data safety as well as data processing, (3) adapt the sampling of sensors to certain scientifically interesting events 4) Collect significant events. Moreover, near-real time data access (<12h) is necessary if the data from an observatory should be used in the context of ocean forecast (e.g. Copernicus Marine Environment Monitoring Service) via the GTS/TESAC data access protocol. Real-time access recently gained always more importance because they can provide critical information for the study of ecosystems, water quality, and fisheries, as well as data for long-term climate change studies (ref. <http://www.seabird.com/real-time-ocean-observing-systems-inductive-modem-telemetry>). Moreover, the real-time data transmission

will allow the data manager and the organization responsible for the observatory to check the status of the instruments, and made the data publicly available for the end user.

The development of satellite, radio frequency, and cell phone telemetry has made real time remote oceanography increasingly practical. However, before these telemetry techniques can be exploited, the data from underwater instruments must first be brought to the surface.

#### 1.3.4.1 Underwater

Traditionally, underwater-to-surface data transmission was accomplished using **direct cable connections**. However, such cables are bulky, expensive, and unreliable, and the positions (and number) of individual sensors are fixed once the cable is designed and manufactured.

**Acoustic telemetry** is a substitute for direct cables. However, acoustic methods result in an even more costly and complex system; additional battery packs are required, depth is restricted due to limited transmission range, and they are subject to a multitude of error sources and failure modes.

Acoustic modems (Figure 1.3.4.1 a) were designed to combat the three main obstacles in underwater communication; poor reliability, low data rate and high power consumption. ESONET organized an intercomparison exercise and provides the following conclusion in ESONET Label documents

Evologics ([www.evologics.de/en/products/acoustics/](http://www.evologics.de/en/products/acoustics/)) modem are used at MoMAR observatory. Devologics (<http://www.develogic.de/products/underwater-communication-systems/ham-node/>) modems are used by GEOMAR. Link-Quest (<http://www.link-quest.com/html/intro1.htm>) is one of the main manufacturer of acoustic modems. Their modems are two-way, half duplex modems, which has a link layer communication protocol. They also contain internal buffer for data storage. These acoustic modems provide completely transparent RS-232 interface to any instruments or PC's. Once the modems are powered up they are ready for service. Despite their valuable functionality, however, their use can be limited by the presence of strong density gradients throughout the water column. In the case of links between seabed platforms or moorings and a separate buoy an acoustic simulation study may optimize the positioning of the relay buoy.

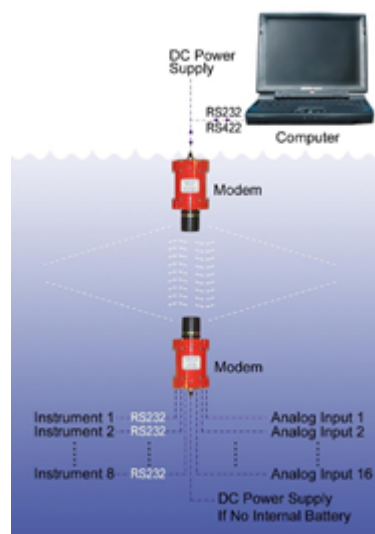

Figure 1.3.4.1 a: Underwater acoustic modems ([http://www.link-quest.com/html/pic\\_modem\\_config.htm](http://www.link-quest.com/html/pic_modem_config.htm))

## **Inductive modem**

Inductive modem technology provides a convenient, economical, and reliable solution while still maintaining flexibility (ref. Seabird application note n.92)

The Inductive Modem (IM) System (or 'Inductively Coupled Modem') employs the mooring cable as its transmission medium, eliminating the need for additional conductors. An Inductive Modem Module (IMM) transmits sensor data to the surface by applying a signal to the internal winding of a cable coupler. This system induces a signal in the single-turn secondary winding formed by the mooring cable passing through the coupler. The signal is retrieved at the surface by a similar configuration. Each coupler is made up of two halves, allowing it to simply clamp around the cable as opposed to having to thread the cable through the unit.

Each cable coupler contains a transformer that magnetically couples the IMM to the mooring cable. Transformers cannot operate at zero frequency (DC) and are inefficient at very low frequencies; although it is improbable that the serial data will consist of all ones or zeros, the IM system needs to account for this possibility. To allow reliable transmission of such data, it is impressed upon a high-frequency carrier waveform. The carrier encoding is performed by MODEM devices (from MODulator-DEModulator), which modulate the carrier at the data source and demodulate it at reception back into the serial form for use by the target PC or CPU.

### **Principles of Inductive Coupling**

Each cable coupler contains a transformer. The toroidal transformer consists of a circular ferrite core and two coils, which share a magnetic field. By applying an AC voltage to an 8-turn primary winding, a voltage of half the amplitude will be induced in a 4-turn secondary winding, as shown in Figure 1.3.4.1b.

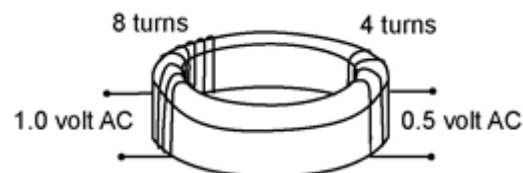

*Figure 1.3.4.1 b: Transformer Operation Example*

### **Typical Inductive Mooring**

A typical ocean mooring is shown schematically in Figure 1.3.4.1 c. The mooring cable is a plastic-jacketed galvanized steel wire rope, a type frequently used for non-inductive oceanographic moorings because of the corrosion resistance provided by the plastic jacket. The ends of the wire rope are terminated with steel thimbles or swaged eye terminals. Deep moorings typically employ synthetic line or stainless chain below the lowest instrument.

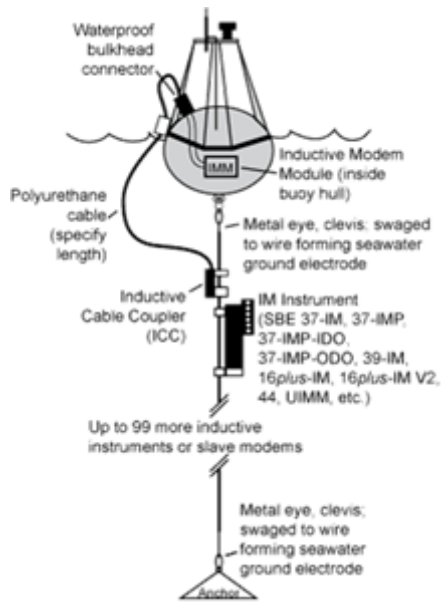

Figure 1.3.4.1 c: Typical inductive modem configuration

Individual inductive modem instruments may be clamped along the mooring cable at any position. It is not necessary to break the cable at the instrument positions or to provide any electrical connection between instrument and cable. Each instrument can be freely moved up or down the cable.

### Direct Connection Inductive Mooring

A second configuration makes use of a direct electrical connection between the surface buoy and the top of the mooring cable, as shown in Figure 1.3.4.1 in this configuration, the plastic-jacketed cable is brought inside the buoy. The buoy must be mechanically secured to the top of the cable without compromising the electrical insulation of the plastic jacket. The IMM connects to both the galvanized steel wire rope and to the buoy hull (or other seawater return) via a small Direct Connection PCB, co-located with the IMM inside the buoy. The ICC is eliminated, but connecting the buoy to the mooring cable may be more complicated.

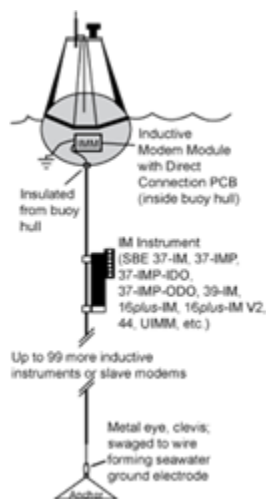

Figure 1.3.4.1 d: Direct Connection Inductive Mooring

### Cable-to-Shore Inductive Mooring

As shown in Figure 1.3.4.1 e, instruments may be placed at any position along a plastic-jacketed wire rope leading from shore. Here the problem of insulating the inner conductor at the shore end is easily solved, making the direct-connection approach to the IMM the preferred method.

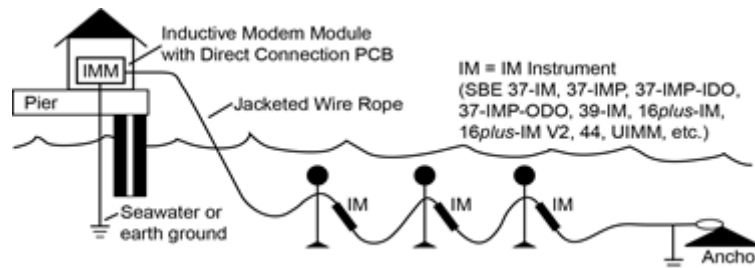

Figure 1.3.4.1 e: Cable-to-Shore Mooring

### Through-Ice Inductive Mooring

Figure 1.3.4.1 f shows a mooring for through-ice applications. Both ends of the mooring cable must be immersed in the seawater to complete the circuit.

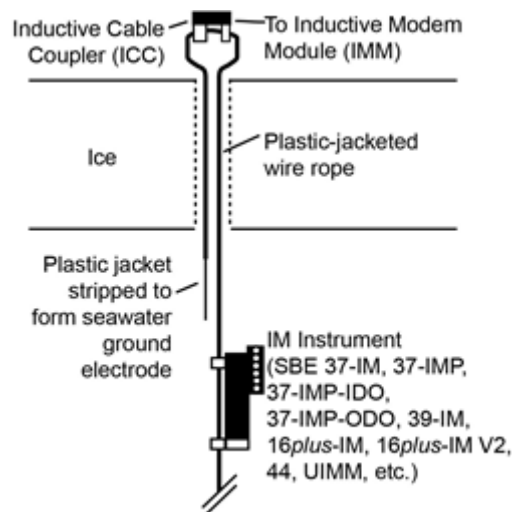

Figure 1.3.4.1 f: Through-Ice Mooring

#### 1.3.4.2 Surface to shore/positioning system

A typical **real-time data** transmission system from the open sea to shore can consist of the following parts (we report here the case of the Italian **E2-M3Aobservatory**, located in the Adriatic Sea, Eastern Mediterranean):

- An onboard controller and a GLOBASTAR modem with its antenna.
- A computer and an external 56Kb modem ashore.

**At the E2M3A** telemetry/controller buoy is based on a Persistor CF2 computer running a DOS-like operating system. The CF2 has a Motorola 68332 processor, 512 kB of RAM and uses a 1GB CompactFlash card to store programs and data.

The controller has an 8 channels 12bit A/D converter to monitors internal voltages, currents and temperatures and 7 RS232 serial data connections to interface:

1. the Globalstar Satellite Modem or allowing access to the system when the buoy is on deck.
2. the meteo sensors, compass, pyrometer, and infra-red radiometer.
3. the GPS receiver.
4. the underwater SeaBird SBE37 ODO.
5. the underwater Pro-Oceanus pCO<sub>2</sub>.
6. the underwater Sunburst SAMI-pH.

The Persistor uses digital output lines and a power system monitor to detect failures of power and switch power supplies to the Seabird SBE37-ODO, meteo sensors, compass, pyrometer and radiometer, GPS, pCO<sub>2</sub>, SAMI-pH.

The GPS receiver is necessary to keep the clock of the data acquisition and control electronics correctly synchronized with the Greenwich Meridian Time and to get the correct position of the buoy: detection of a position out of a pre-defined "Watch Circle" will generate an alarm condition.

About Globalstar dial-up mechanism, all calls are initiated by the buoy. At pre-set times the Persistor turns on the power supply to the satellite modem and waits for several seconds to give it time to register with the satellite network. The Persistor then sends a series of AT commands and records various status parameters. If all is well it then sends an AT dial command to call a dedicated phone line at OGS where an analogue modem is waiting. The call is answered by a PC running a land station receive software developed by OGS and written in LabView. The program that answers the call receives an ASCII file of unknown size in 1024 byte blocks. The buoy controller performs various tasks according to a programmable schedule to acquire data from all the sensors and instruments to which it is interfaced.

### 1.3.5 Energetic autonomy

Historically, deployed autonomous buoys were powered by diesel generators, nuclear power and wind generators with different degrees of success. The use of batteries (initially non-rechargeable) started in the mid-1970s due to the progress in technology which got to reduce power requirements of subsequent electronics and transmission equipment. Nowadays, most of observatories use a combination of power generators and energy storage in order to keep the electronics and the transmission system working. There are observatories whose power supply is through cable. MBARI has a long experience with the MOOS buoy, the running cost are high and this is the reason why this concept has not been extended<sup>vi</sup>. However, these observatories are reduced as consequence of the costs of the infrastructure.

#### 1.3.5.1 Cabled

In cabled observatories, the energy is distributed by an underwater network consisting in land power station, nodes, junction boxes and possibly front end distribution to instruments (low voltage). Two type of design are implemented with either DC power or AC power in the



backbone cables between shore and nodes. The consensus is to end up with DC power around 300V at junction box level.

#### **1.3.5.2 Autonomous**

The autonomous buoys are powered using power generator systems such as solar panels, wind turbines and wave activated generators. Normally, photovoltaic panels power rechargeable secondary batteries that directly drive the buoy systems. However, photovoltaic panels may be damaged at sea or during buoy servicing, so a small number of primary batteries normally are still used as a reserve supply until a service visit can be carried out. Power requirement for the buoy depends largely on the number and types of sensors used the sampling frequency and the consumption due to frequency of transmission.

#### **1.3.5.3 Energy storage**

Battery purchase is a large investment and the proper size and type of battery is critical in your decision-making. There are many things to consider between the different technologies, load requirements and longevity. The capacity of the battery is selected based on the power consumption estimating various sampling rates and frequencies and the duration and intensity of the sunlight throughout the year if solar panels are our choice as power generator. We can also consider the energy produced by power generators such as wind and wave if they are included. There are a large number of batteries available such as AGM, Supercapacitor and lithium-ion. The implementation of the batteries onboard buoys must comply with safety rules in order to avoid explosion.

#### **1.3.5.4 Power generation**

Photovoltaic (solar) systems are a dependable power source, even at high latitudes. Solar Panels work on a simple principle, when sunlight is exposed to the panel surface, electrical power is produced. Most solar panels have a long life and are typically selected based on the wattage (power) produced for the buoy power requirements. Among the Solar Panel options, fixed frame and semi-flexible solar panels are the most used for buoys. The fixed frame panels tend to be rigid and are constructed of materials like tempered glass and aluminium to make them very durable. The fixed frame panels power output varies from model to model but generally is anywhere from 10 watts to 225 watts.

#### **1.3.5.5 Wind turbine**

Wind is a form of solar energy and is a result of the uneven heating of the atmosphere by the sun, the irregularities of the earth's surface, and the rotation of the earth. Wind flow patterns and speeds vary greatly over the land, since they are modified by bodies of water, vegetation, and differences in terrain. However, they are more constant over the sea, especially in the open-sea. Humans use this wind flow, or motion energy, for many purposes: sailing, flying a kite, and even generating electricity. Hence, it is also used to provide power to oceanographic instruments deployed under the water.

Wind turbines convert the kinetic energy in the wind into mechanical power. This mechanical power can be used for specific tasks (such as grinding grain or pumping water) or a generator can convert this mechanical power into electricity (ref. <http://energy.gov/eere/wind/how-do-wind-turbines-work>). The smallest turbines are used for applications such as battery charging for auxiliary power on oceanographic buoys.

Most manufacturers can provide you with a system package that includes all the parts you need for your particular application:

1. A controller
2. Storage batteries
3. An inverter (power conditioning unit)
4. Wiring
5. Electrical disconnect switch

The amount of electricity a wind turbine can generate will depend on the wind speed at the site and the turbine's capacity rating. If a model has a rated capacity of 1 kW, it means it will produce 1 kWh of electricity per hour when exposed to a specific rated wind speed. This specific rated wind speed varies between different models and manufacturers, but is generally somewhere between 11-15 metres per second.

Although capacity ratings are a useful guide, in the real world a turbine will not be exposed to ideal conditions or the 'rated wind speed' at all times. This means turbines will typically generate, on average, only 10-40% of their rated capacity every hour over a year.

To work out roughly how much electricity a turbine will generate on an average day, multiply the rated capacity by 24 hours, and then multiply it again by percentages ranging from 10 to 40, to reflect the typical range of wind available (ref. <http://www.energywise.govt.nz/your-home/generating-your-own-energy/wind>).

*For example:*

*A 1 kW wind turbine might generate between 2.4 kWh and 9.6 kWh a day on average (i.e., 1 x 24 hours x 10% = 2.4 kWh/day; or 1 x 24 hours x 40% = 9.6 kWh/day)*

More recent technologies must be considered: Wave energy converters and fuel cells are under validation by some institutes, they may be complementary sources of energy in the future.

## **2. Pre-Deployment procedures (NOC, HCMR, CNRS, UPC)**

### **2.1 Maintenance**

Maintenance plays a critical part in building a successful network of ocean platforms, and requires careful planning, correct use of resources, that include not only highly qualified personnel, specialized equipment, but also, many times, utilization of costly ship time. Specific characteristics referring both to local conditions and equipment requirements have to be taken into account.

Platform maintenance procedures can be split into those that can be carried out on site, and those that can be carried out on land. Rationale for choosing one of these methods and the respective limitations will be discussed in the next paragraphs.

#### **2.1.1 Maintenance on site**

Although carrying out maintenance on site has the obvious advantage that the instrument array can be re-deployed almost immediately, it is limited by both the facilities available and the extent of maintenance procedures that can be offered, but also the strict time limitations related to possibly involved ship-time, weather conditions etc. Thus, any on-site

maintenance procedure, periodicity, and means involved has to be carefully defined and planned beforehand, especially if a ship and its crew are involved in the operation.

Recommended maintenance procedures that can take place on board the maintenance vessel are:

- Visual inspection of the buoy or station hull and external housing for damage
- Data downloading from the instruments internal memory
- Cleaning the station housing and external components
- Replace by the spare platform or
- Check and replace if necessary:
  - power related components (power line, batteries, solar panels, etc.)
  - cabling or connectors
  - station telemetry modules (antennae, positioning systems, etc.)
  - navigation lights, radar reflectors, etc.
  - sensors (specific procedures regarding sensors in the following paragraph)
  - broken or damaged parts and components
  - mooring line rope or cable mooring line components
  - shackle axis and tapered pins.
  - mooring line anchoring system
- Checking and testing the functionality of all the components and subsystems
- Applying antifouling coatings on the parts in contact with seawater.
- Visual inspection of the mooring line for damage
- Cleaning the underwater components from shells and algae
- Check the free movement of each swivel around its head. If any swivel head sticks it must be replaced.

Recommended maintenance procedures that can take place on site with an ROV (or divers in shallow areas) for seabed observatories:

- Data downloading with underwater wireless connection
- Visual inspection of the seabed stations
- Connection of replaced instruments or new instruments
- Connection of new battery packs
- Removal and deployment of associated autonomous instruments (OBSs, temperature loggers, landers, etc.)
- Complete check of the connection to shore by a communication between the ROV team onboard the ship and the onshore remote maintenance team
- Checking and testing the:
  - release system of mooring lines and standalone nodes
  - underwater communication systems (acoustic modems, inductive modems)
- Applying antifouling and anti-corrosion coatings and anodes (discussed in greater extend in following paragraphs)

### 2.1.2 Maintenance on land

Station recovery and subsequent maintenance procedures carried out on land have the obvious disadvantage of instrument downtime, and possibly a second ship involvement for re-deployment, but they provide for ample time and facilities to carry out detailed work, maintenance and calibration, that would not be possible on site. The concept of long term monitoring of Eulerian observatories requires the management of spare components and spare sensors following the calibration protocols. It has the advantage to avoid a ship waiting

for instrument repair onboard, and the need to bring all experts onboard. Furthermore, new components and upgrades can be installed and all the modules can be tested in detail.

### **2.1.3 Instrument maintenance**

Components that would benefit from maintenance on land are instruments (sometimes individual sensors), actuators and mobile systems, front end electronics and loggers. Since each sensor has dedicated maintenance procedures, described in the manufacturer's manual, and many times demanding specific spare parts and equipment or it can be time consuming, so it can only be carried out on land.

It is a good practice to have available a second set of serviced and calibrated sensors, so the ones operating in the field can be easily and swiftly replaced.

General maintenance guidelines differ for sensors operating in the air and sensors operating underwater. But when robustness is concerned, all FixO3 equipment will also be possibly submerged by seawater during their lifetime (storms, transfer for maintenance from small boats) and must be considered as underwater equipment.

#### **2.1.3.1 Sensors operating in the air**

Most important recommended maintenance procedures are:

- Applying antifouling and anti-corrosion coatings and anodes (discussed in greater extend in following paragraphs and Appendix C)
- Visual inspection
- Data downloading
- Cleaning
- Replacement of broken parts
- Servicing moving parts (e.g. anemometers)
- Replacement of connectors and cables if necessary
- Installing fresh batteries if necessary
- Checking memory if necessary
- Applying manufacturer's instructions and application notes
- Checking sealing and replacement of O-rings if necessary
- Leakage test (checking inside pressure of the housing when such system is implemented)
- Testing

#### **2.1.3.2 Instruments operating permanently underwater**

The maximum sensor life on the shelves should be considered before its deployment. Servicing of the sensors should be made so the sensor doesn't stay stored longer than recommended. For example, nitrate sensors need to be store with a wet cap protecting the probe. However, once the small volume of liquid in the wet cap has reached equilibrium of ionic transfer the depletion of gel is lessened. Thus, the sensor values may start drifting sooner than expected during long term deployments.

The general procedures are valid and for the sensors operating inside the seawater, but in this case it is strongly recommend performing a leakage test. Especially for the sensors operating attached on a mooring line or a bottom frame a pressure test should be performed if possible. The majority of underwater sensors are sensitive to biofouling and their data are significantly affected usually weeks or even days after the field deployment. The techniques

and materials for the removal of fouling are usually described in the sensor manual and should be included in the maintenance procedures. A summary of those procedures, for the main categories of oceanographic sensors, is presented in the table below.

Table 2.1.3.2a: Maintenance procedures for oceanic sensors with cleaning methods

Sensor type	Maintenance	Materials
Acoustic sensors	Cleaning of the acoustic transducers	Fresh/DI water, low acid concentration solutions
CTDs conductivity sensors	Deep cleaning of the conductivity cells	Fresh/DI water, Triton-X, bleach, white vinegar
Optical sensors	Cleaning of the optical window	Fresh/DI water, low acid concentration solutions, white vinegar
Dissolved oxygen sensors	Deep cleaning of the sensing membrane	Fresh/DI water, Triton-X, bleach, white vinegar
Chemical sensors, analysers	Deep cleaning of the flow circuit or membrane	Fresh/DI water, laboratory cleaning agent

## 2.2 Corrosion prevention

FixO<sup>3</sup> standards requires that all the biofouling and corrosion protection methods will be completely presented and detailed in the Deployment document. This will include the estimate of the degree of protection of all parts of the observatory and sensors as well as a description of the systems that are not protected and the expected consequences. The descriptions must be compared with examples of in-situ tests and previous deployment experiences of the observatory or other observatories or submitted to corrosion experts (see Appendix C).

The environment of FixO<sup>3</sup> observatories is one of the most corrosive environments on Earth. Unprotected steel structures continuously immersed for such long periods show corrosion rates of 100 - 200µm per year. This factor must be considered throughout the design of the observatory since a bad choice of materials could accelerate corrosion rates. There are various types of coating and they are often combined with cathodic protection. Coatings are the most common methods used for the protection of materials in offshore environments and the most common standards of offshore coating are:

- NORSOK M501-revision 5
- ISO 12944-1998/2007
- ISO 20340-2009

Material coating used for FixO<sup>3</sup> observatories must comply with one of these standards. These standards define critical parameters of the coating selection such as the type and condition of the substrate, the environment and possible additional stresses, the surface preparation, the quality of the coatings, the selection of the coatings and the quality control of the substrate. For atmospheric zones it is important to select UV durable topcoats. Non-corrosive materials are strongly recommended instead of steel to improve the quality of the system such as Titanium and plastic. The use of composite materials with marine references is recommended.

The right choice of these materials apply to every element of the observatory including the structure, the connectors, the mechanical interfaces, the cables.... These elements must be carefully isolated to prevent corrosion and electrolysis. (see more details in Appendix C. The deployment document must specify all materials used in each of the parts of the system and any corrosion protection system of steel if these cannot be avoided.

## 2.3 Biofouling prevention

Sensor protection from biofouling must be done with special care since it directly affects the area of measurement. This is especially important for optical sensors, membrane sensors and electrochemical sensors for which the interface between the measurement medium and the sensor sensitivity area must remain intact.

Biofouling is a limiting factor in data acquisition at ocean observatories, especially during long term deployments. Figure 2.3 a shows an irradiance sensor after a one-year deployment during which the bioshutter broke.



Figure 2.3 a: Irradiance sensor after a one-year deployment during which the bioshutter broke.

Biofouling disrupts sensors in short-medium time (down to a few days) and therefore it quickly affects the quality of their data. Typically, bio-fouling creates a shift in the measurements that is particularly important for long term observations, shallow waters and near shore observatories. The appropriate techniques must be used according to the location of the observatory and the duration of the deployment. FixO3 observatories should ideally use proven solutions for sensor housing and sensing areas that could provide protection from biofouling while not interfering with the measurements.

The protection must not affect the measurement or the environment while staying within the specifications of the observatory. For example, in order to endure the entire deployment, it should not consume too much energy and be reliable to aggressive conditions such as corrosion, sediments, hydrostatic pressure.... Today, the frequently used techniques are

volumetric techniques such as bleaching or chlorine generation by seawater electrolysis and copper tape. Volumetric techniques act on small volumes surrounding the sensor area. Surface techniques on the sensing area are also possible and include wipers, copper shutter, water jets, ultrasonic sound, chlorine production,

Because observatories often look for limited cost, low power and easy to install on existing instruments solutions, other solutions that respond to the FixO3 requirements will be accepted if they are tested in the laboratory as well as in-situ where they are exposed to more harsh conditions. The time between maintenance is often directed by the biofouling protection, it is probably good for FixO3 policy to promote more efforts to adapt the most suited antifouling method to each sensor, and spend some budget for this aim.

Since bio-fouling may alter the oxygen, fluorescence and other measurements of the water, the housing of the instrument and the instrument frame must be protected from bio-fouling. Passive solutions to housing protection are to be chosen among the following options which has shown to be the most effective:

- Hull protection paint
- Antifouling paints with active biocides such as copper compounds, copper oxides and cobiocides chemicals
- Non-stick coatings paints based on silicon or fluorinated polymers
- Copper screen grid
- The addition of active anti-fouling devices may be a good choice for essential parameters in critical environment provided the time series of the active protection is recorded in the same data management system as the measurement for further QC.
- electromechanical biofouling protection devices
- chlorination by electrolysis or bleach injection
- UV radiation

For solutions such as paints and biocides, it must be demonstrated that the quantities used does not disrupt the environment of the observatory. This includes hazardous effects in the environment and interferences with the measurements. Among these solutions it is important to consider the high power consumption of electromechanical devices since they could have a strong impact on the duration of the observatory. Also, the non-stick coating solutions are usually biocide-free but they require of currents to remove the fouling, thus they are not appropriate for all locations of observatories.

FixO3 standards require a solution that protects the sensitivity of the sensor for the duration of the deployment. Passive biofouling prevention methods and active one are complementary in many cases.

## **2.4 Sensors configuration/Installation**

### **2.4.1 Observatory payloads**

The fixO3 observatories must include various elements allowing to successfully achieve their mission. They must carry sensors to allow measuring the chosen parameters for the specific location and power supply for the duration of the deployment. Additionally, depending on the type of the observatory, they can include meteorological payloads or data transmission systems for (quasi-)real data. Standardised payloads for all platforms is hard to achieve without the consideration of their goals and characteristics. The design should be optimized for each particular location and goals.

#### **2.4.1.1 Meteorological payload**

Meteorological payloads could be added to observatories with sea-surface access. These for instance, do not necessarily include bottom observatories. Meteorological payloads should measure parameters at the water-atmosphere surface such as temperature, humidity, air pressure, wind and position. Since these sensors are exposed to harsh conditions, they are vulnerable and they must be replicated when possible. It is recommended that these measurements are transmitted in quasi-real time as a feedback of the conditions of the observatory. Meteorological payload must be installed separately from the science payload in order to preserve the reliability of the other payload.

#### **2.4.1.2 Oceanographic payload**

Oceanographic payload must respond to the science scope of the observatory. The observatory must always include sensors to measure basic parameters such as temperature, salinity and pH. Other sensors may include pCO<sub>2</sub>, oxygen sensors, cameras, fluorometer, plankton sensors, nitrate... All the parameters that the observatory intended to measure must be described in the Deployment document as well as the sensors that are used for this purpose. This description must include an estimate of the accuracy of these measurements and how the chosen sensors respond to these specifications. A description of the characteristics of various instruments will be provided by [FixO3](#) to facilitate the choice of the sensors.

#### **2.4.1.3 Seabed based observatories modules**

A scientifically powerful component of the seabed based observatories concept is the long time-series collection of multiple variables at a single location. All the bottom observatories should include sensors necessary for climate system monitoring such as temperature, conductivity (salinity), pressure (depth), turbidity, dissolved oxygen, ocean currents, and passive acoustics suitable for all sites and depths. These variables, known as Essential Climate Variables (ECV), were defined to support the work of the UN Framework Convention on Climate Change (UNFCCC) and the IPCC. Moreover, other variables can be considered, such as the remaining ECV and other key chemical variables (e.g. Chl-a, pH, CO<sub>2</sub>, CH<sub>4</sub>, H<sub>2</sub>S, Eh, and hydrocarbons). In addition to an oceanographic payload, bottom observatories will also carry sensors specific to measurement of the seafloor environment. Biological payloads include cameras for visual monitoring of the seafloor (e.g. megafauna, phytodetritus input, bioturbation). Measurements of the optical characteristics of the water (light transmission, backscatter and fluorescence) are also recommended. Hydrodynamics are monitored with current meters and ADCP. Sediment traps can also be deployed from bottom observatories monitoring re-suspended as well as allochthonous material. Broadband ocean bottom seismometers, flowmeters and methane sensors are used for marine geosciences (e.g., seismic waves, gas seepage, etc.). Other sensors include hydrophone, sonar, tsunami pressure sensor, hydrophone array, precision range meter for crustal movement observations, potentiometer, magnetometer, tiltmeters....

#### **2.4.2 Sampling scheme**

Sampling rates of the sensors mainly depend on the temporal variations of the parameters that are to be measured. However, it is important to consider the duration of the observatory as well as the power and data storage availability in order to define the sensor configurations. Ideally, fixO3 observatories will have remote communications that will not only allow data accessibility but also configuration changes of the sensors.



While the sensor configuration depends on the observatory framework, recommended values are as follow:

- A millisecond for seismic parameters
- High frequency sequences for acoustics (ADCP, passive or active)
- A fraction of hour for temperature, depth and salinity
- A fraction of a day for pH and CO<sub>2</sub> sensors
- A fraction of a day for fluorometers
- A few hours for nitrate sensors

The choices of the sensor configuration must be stated in the deployment document. This should include a description of how the chosen configuration will take the appropriate measurements for the specific science goals in the observatory site. It will also have a technical report on the impact on the duration of the observatory due to data storage and power consumption.

### 2.4.3 Sensors validation/calibration

In the chain of data acquisition, sensor calibration in the field and in the laboratory aims primarily at ensuring the measurements' accuracy. Regular, robust, well-documented calibration procedures will enhance inter-comparability of long-term data from the same or different infrastructures. Sensor calibration should be performed prior to and after deployment in order to apply corrections to the acquired data in case of drift of sensors. The sensor payload of FixO<sub>3</sub> platforms is described in the "Review of the current marine fixed instrumentation, D2.2". According to D2.2, most instruments of FixO<sub>3</sub> platforms are used to measure temperature, salinity and oxygen. However other parameters such as currents, fluorescence, suspended matter, nutrients, seismology parameters, absolute pressure, chemical analyses, camera imaging, acoustic sound are successfully measured. Biofouling is reported as the most common problem in producing high quality data sets.

The strategy followed and the effort invested in the production of data for each parameter depends on the maturity, sensitivity to drift and the technical characteristics of the sensors. Overall, standardized methods exist for temperature and salinity sensors. With the exception of bio-fouling problems faced by some conductivity sensors, data derived from fixed-point observatories are of appropriate quality for many applications for both parameters. It is more challenging to acquire accurate measurements of dissolved oxygen and chlorophyll from automated sensors. At first, fluorescence, from which chlorophyll concentrations are derived, has a complex dependency on environmental conditions and phytoplankton community composition. Both artificial and natural calibration references exist but none of them is used as a commonly accepted standard. For the dissolved oxygen calibration, the Winkler method, which has very good accuracy and precision, is used as the calibration standard. It requires laboratory equipment though and in combination with the fact that, at least some of, the market's automated oxygen sensors are prone to drift renders the monitoring of their performance challenging.

#### 2.4.3.1 In the lab (biogeochemistry parameters)

To reduce the costs and maintenance time of the sensors some of the observatory operators have established calibration facilities of the "core" parameters measured by fixed-point observatories. Best practice recommendations for the calibration of the "core" parameters are given below.

## Temperature and conductivity calibration

Temperature and conductivity calibration is performed by placing the sensors in a thermostatic calibration bath filled with seawater. The calibration points are selected according to the expected oceanographic range of temperature and salinity. For each calibration point the temperature reference is obtained by averaging a number of measurements taken with a calibrated Standard Platinum Resistance Thermometer (SPRT). The conductivity reference is obtained by inverting the salinity measurement of a water sample at each calibration point. The reference temperature is used for the inversion. A laboratory salinometer standardized with IAPSO standard seawater is used to obtain the reference salinity of the water samples.

Recommendations:

- Sensors should be visually inspected prior to calibration.
- Real-time monitoring of the conditions of the calibration bath can ensure the bath stability and homogeneity at the calibration points.
- Sensor handling and storage should follow the recommendations of the manufacturer. Sensor calibration should be performed prior to and after the deployment. The maximum period between two calibrations should not be more than one year.
- Reference instrumentation should be regularly sent to the certified laboratories or to the manufacturer for calibration.
- Calibration results should be accompanied by a declaration of uncertainty and information on reference material.
- The calibration and the deployment history of the sensors should be available for traceability. In the long-term this will provide useful information on the sensor performance and will reduce the risk of failures.

## Chlorophyll calibration

For the determination of chlorophyll fixed-observatories use optical sensors. Optical sensors sense a proxy, the fluorescent part of chlorophyll in the cells. The ratio of fluorescence and chlorophyll is variable and complex to determine. Also the response of the instruments to reference standards is sensor-specific. A common accepted method in calibrating optical chlorophyll sensors does not yet exist. The purpose of calibration of Chl- $\alpha$  fluorometers is to provide a reference to which all fluorescence measurements will be related through arbitrary fluorescent units. The use of fluorescence standard will ensure traceability. Most importantly it will provide comparability between sensors and deployments. Dissolved chemical standards, solid standards or algae cultures may be used as primary calibration standards. Manufacturer calibration can also be used but the operator should be able to track the instrument performance. Cultures should not be used as primary calibration standards because their fluorescence to Chl- $\alpha$  ratio varies. A review of standards for calibration of *in situ* fluorometers is given in Earp et al. (2011).

After the calibration the ratio of the fluorescence and the Chl- $\alpha$  may be determined, this is the validation process. The purpose of fluorescence validation is to explain the variability of fluorescence to Chl- $\alpha$  ratio. The validation process is composed of analysing natural phytoplankton samples (or cultures) assuming their optical properties are similar to those of the site the sensors operate. Chl- $\alpha$  is extracted from water samples and used as reference. Sensor measurements are then adjusted to the Chl- $\alpha$  concentration, usually through linear adjustment. Other auxiliary measurements, such as irradiance level or measurements from additional fluorescence channels, may be used to improve the fit.

#### Recommendations:

- Instruments should be cleaned and optically checked before calibration.
- Instruments should be sent on a regular basis to reference calibration lab or manufacturer for maintenance. Storage and handling should follow manufacturer recommendations.
- Calibration should take place in constant temperature. Instrumentation used should not cause background fluorescence.
- The effect of light on measurements should be taken into account. Background light should be minimum. PAR and irradiance sensors are useful to correct such effect in the time series.
- Keep trace of the procedure and information of reference materials used. The calibration coefficients and the variability of fluorescence to Chl- $\alpha$  ratio should for each sensor should be stored.
- Linearity of the sensors over the measuring range should be verified.

#### Oxygen calibration

We address here two types of autonomous sensors for measuring dissolved oxygen, electrochemical and optical. The electrochemical sensors, such as SBE43 from Seabird Electronics, have high initial accuracy 2% of oxygen saturation and precision 1 $\mu$ mol/l. Oxygen measurements change the chemistry of the electrolyte of the sensor and result in a slow drift. The operation of optical sensors, such as the Aanderaa optode, is based on the fluorescence quenching principle. The response time of the optical sensors is slow compared to that of the electrochemical sensors. The advantages of the optical sensors are the long-term stability and the high accuracy, ~5 $\mu$ mol/l, provided sufficient time is given to equilibrate.

Both types of sensors are calibrated against the Winkler method (Winkler, 1988) that has high precision and accuracy (2 $\mu$ mol/l). High accuracy/precision results may be obtained following a multi-point calibration protocol. Multi-point calibration requires an apparatus/bench capable of creating different DO concentration. Temperature and salinity are measured during the calibration experiments. The effect of pressure on the DO sensors is not taken into account at present. The level of sophistication of such the benches, which are custom made, vary. IFREMER, Mediterranean Institute of Oceanography (CNRS) and Max-Planck Institute facilities are some examples of the state of the art facilities for oxygen calibration nowadays. Recommendations on specific equipment cannot be given at present. In general, the bench used should be thermally insulated and of high stability and homogeneity. An easy way of producing DO concentration gradient to perform multi-point calibration is to change the saturation of the water by changing its temperature.

The response of the optical sensors to the DO concentration can be linearized (Demas et al., 1999) and thus a multi-points calibration has to be performed. It is crucial that the temperature sensors be carefully calibrated before the oxygen calibration.

#### Recommendations:

- Only dedicated staff using specialized equipment should perform the DO calibration.
- The accuracy of the reference measurements (e.g. Winkler titration) depends strongly on the operator. Inter calibration experiments should be performed to eliminate that factor.
- Sensors should be visually inspected prior to calibration.

- The calibration facility should be monitored in real-time to ensure homogeneity and stability at the calibration points.
- Sufficient time should be given to the calibration facility to settle at the calibration points.
- Instrumentation should be handled and stored according to manufacturer recommendations. Detailed logbooks of calibration experiments should be archived for traceability.
- If temperature-conductivity sensors are used to monitor the state of the calibrating facility, they should have been carefully calibrated.
- Calibration results should be accompanied by a declaration of uncertainty and information on reference material.

*Earp, A., Hanson, C. E., Ralph, P. J., Brando, V. E., Allen, S., Baird, M., Clemenson, L., Daniel, P., Dekker, A. G., Fearn, P. R. C. S., Parslow, J., Strutton, P. G., Thompson, P. A., Underwood, M., Weeks, S., and Doblin, M. A.: Review of fluorescent standards for calibration of in situ fluorometers: recommendations applied in coastal and ocean observing programs, OPTICS EXPRESS, 19, 16768-26782, 2011.*

### **pH calibration**

Calibration of the pH sensors will be performed ideally by a calibration lab but still by the manufacturer. Validation in the lab should be performed to check the calibration and possible drift of the measurements for sensors that are stored for a long period of time. The validation of pH sensors requires temperature measurements in order to perform correction of the recorded data. Sensors may be set up in continuous reading mode with a SBE sensor in a Tris buffer #26 solution of a known pH. It is important to let the sensor warm-up and stabilize for some time before taking the measurements. Typical values of a SeaFET pH sensor are shown in the table below.

*Table 2.4.3.1a: SeaFET pH sensor calibration tests*

Date	S/N	T [°C]	pH internal	pH external	pH Tris#26
19.05.2015	63	20.1	8.211±0.013	8.270±0.022	8.24
19.05.2015	257	20.1	8.217±0.016	8.240±0.016	8.24
20.06.2015	63	22.0	8.177±0.002	8.129±0.007	8.188
20.06.2015	257	21.9	8.223±0.005	8.223±0.030	8.191

### **Recommendations:**

- Validation of the sensor should be done with special care of the probe. Special equipment may be needed to keep the probe wet and protected when the protective cap is not on during calibration.
- Only dedicated staff using specialized equipment should perform the calibration. However, validation of the sensor should be done in the lab with a known solution.
- The accuracy of the reference measurements depends strongly on the operator. Special attention should be taken with measuring the temperature and applying the correction factors.
- Sensors should be visually inspected prior to calibration. For instance, chemical sensors need to be checked for water flow across the sensor.

- The calibration should be done to avoid extended length of storage time prior to deployment.
- The sensor should be stored between calibrations according to the manufacturer's recommendation and FixO3 documents. For instance, in order to avoid gel depletion, the probe needs to be stored in a wet cap containing seawater.
- Instrumentation should be handled and stored according to manufacturer recommendations. Detailed logbooks of calibration experiments should be archived for traceability.
- Calibration results should be accompanied by a declaration of uncertainty and information on reference material.

### **Nitrate calibration**

The nitrate sensors such as ISUS or SUNA calibration uses one-point calibration method. This involves nitrate calibration standards at various concentrations. Common values are 5, 10, 20 and 40  $\mu\text{M}$  concentrations prepared using nitrate standard stock of 1000 $\mu\text{M}$  and ultra-pure deionised water (Milli-Q DIW). The values obtained during these measurements should agree within a few percents with the manufacturer's calibration. Figure 2.4.3.1 a shows an example of a ISUS sensor calibrated with the Milli-Q DIW sample for both in-lab and on-board bench calibration. It shows values in the range of the Satlantic's specifications (red dots) of  $0 \pm 2 \mu\text{M}$  for Milli-Q DIW.

#### Recommendations:

- The accuracy of the reference measurements depends strongly on the operator. Inter calibration experiments should be performed to eliminate that factor.
- Sensors should be visually inspected prior to calibration. The optical windows should be clear and clean.
- The sensor should be stored between calibrations according to the manufacturer's recommendation.
- Instrumentation should be handled and stored according to manufacturer recommendations. Detailed logbooks of calibration experiments should be archived for traceability.
- Calibration results should be accompanied by a declaration of uncertainty and information on reference material.

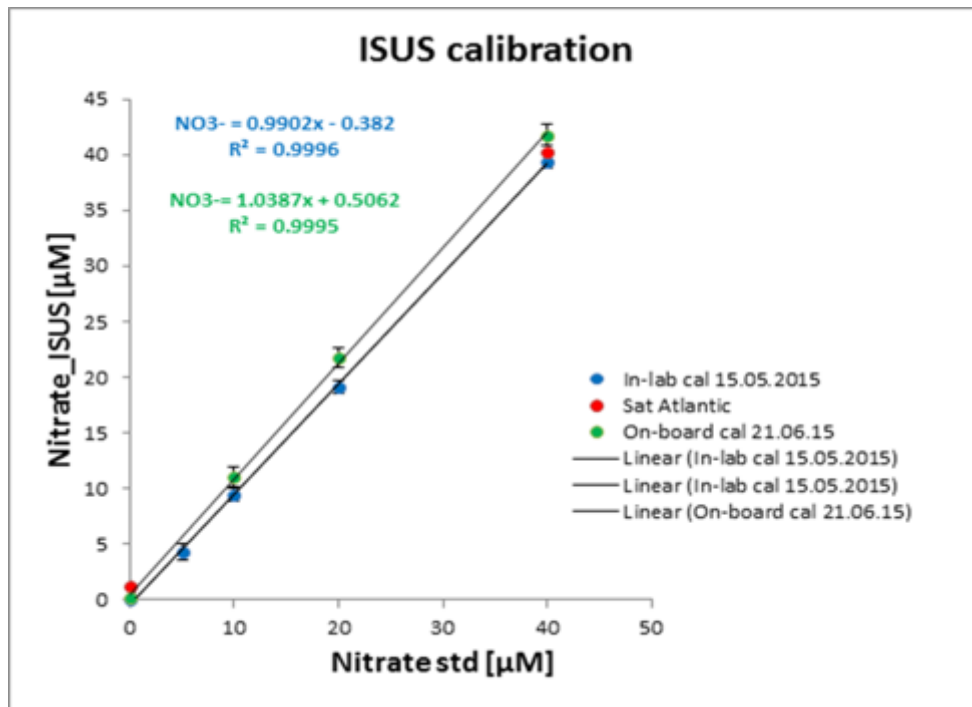

Figure 2.4.3.1 a: An ISUS sensor calibrated with the Milli-Q DIW sample for both in-lab and on-board bench calibration.

## pCO<sub>2</sub> calibrations

To assess seawater carbonate chemistry is challenging because of the complex and not yet fully known interrelation between different forms of the carbonate system. The four main measurable parameters of the carbonate system are Alkalinity, Dissolved Inorganic Carbon (DIC), pH and pCO<sub>2</sub>. If two of these parameters are provided along with temperature, pressure, total phosphate concentration and total silicate concentration the other two can be empirically calculated based on the work done by Lewis and Wallace (1998). To facilitate these calculations openly available Excel based software called CO<sub>2</sub>sys is available on the internet and/or as a cell phone application called CO<sub>2</sub>calc. It should be noted that in seawater only a small portion, some %, of the dissolved inorganic carbon is present as CO<sub>2</sub> gas = pCO<sub>2</sub>.

For aquatic in situ measurements of pCO<sub>2</sub>, four main detection principles have been used:

1. *Infrared (NDIR)*: based on the equilibration of CO<sub>2</sub> gas dissolved in water through a gas permeable membrane to an inner air-filled, pumped gas-circuit of the analyzer, where the CO<sub>2</sub> concentration is measured optically using non-dispersive infrared absorption spectrometry. These sensors often have scrubber that occasionally can remove CO<sub>2</sub>. This gives the possibility of obtaining an internal 0 CO<sub>2</sub> reading to compensate for detector drift. It also leads to that these sensors consume CO<sub>2</sub> which implies that good water circulation should be maintained in front of the membrane. Manufacturers of these sensors include: HydroC™/CO<sub>2</sub>, CONTROS Systems & Solutions GmbH, [www.contros.eu](http://www.contros.eu) and CO<sub>2</sub>-Pro™, PSI, [www.pro-oceanus.com](http://www.pro-oceanus.com).
2. *Colorimetric*: based on optical detection of the pH induced color change of the indicator solution, which is equilibrated with ambient seawater pCO<sub>2</sub> through a gas-permeable membrane. These sensors have to be equipped with a reagent that has to be renewed in-between deployments. SAMI pCO<sub>2</sub> from

- [www.sunburstensors.com](http://www.sunburstensors.com) manufactures these sensor.
3. *Foil based optode*: CO<sub>2</sub> gas diffuses from the surrounding water into the hydrophobic (only gas can pass) pH sensing indicator, where as a consequence the pH is modified. The magnitude of pH change is correlated to the pCO<sub>2</sub> level outside the membrane. The embedded DLR (Dual Lifetime Referencing) material exhibits a pH dependent fluorescence change, which is detected as a phase shift value of returning modulated red light. These sensor foils cannot be used in sulfidic waters (presence of H<sub>2</sub>S) and should always be kept wet during transport and storage. Aanderaa Data Instruments ([www.aanderaa.no](http://www.aanderaa.no)) manufacturers and sells these type of sensors.
  4. *ISFET based sensor*: The principle of pCO<sub>2</sub> measurement using ISFET-pH technology is as follows: Both the ISFET-pH electrode and the Cl-ISE reference electrode of the pH sensor are sealed in a unit with a gas permeable membrane, CO<sub>2</sub> diffuses through, whose inside is filled with an inner electrolyte solution that contains a NaCl solution. The pH sensor can measure changes in pCO<sub>2</sub> from changes in the pH of the inner solution, which is caused by penetration of CO<sub>2</sub> through the membrane. These sensors are not yet commercially available.
  5. *Solid-state electrolyte cell*: Measures partial pressure of CO<sub>2</sub> gas in a gas mixture, which is equilibrated with the water outside the gas permeable membrane. Detection is based on solid-state electrolyte cell. This is a relatively new technology that is in development by e.g. <http://www.franatech.com/index.html>.

There is no absolute reference method for pCO<sub>2</sub> which makes calibrations of such sensors difficult.

One method is to use constant bubbling with gas mixtures with known concentrations of pCO<sub>2</sub>. All sensors are affected by temperature changes therefore for sensors to be accurate the calibrations should be done at multiple temperatures. The gas bubbling method is relatively robust but since it takes long time for the bubbled seawater to reach equilibrium these calibrations can take many days. If reference sensors could be included in the calibrations system, just like it is done in some of the O<sub>2</sub> calibration facilities, the calibration procedures could be speeded up considerably. There are on-going trials to use Cavity Ring-Down Spectroscopy instruments normally used in atmospheric measurements as a reference during calibrations.

Another calibration method is based on changing the pH. A small pH change will lead to a significant change in pCO<sub>2</sub> which can be calculated with CO<sub>2</sub>sys and used as a reference point. Difficulties with this method is again the time for equilibration, the risk of contamination from the atmosphere and that the pH determination will have to be very accurate.

#### 2.4.3.2 In the field

The sensors should be calibrated against the ship CTD when possible. The salinity, oxygen and chlorophyll fluorescence could be calibrated against Niskin bottles. The samples could be analysed during the cruise or in the lab but it is important to take and label them correctly. Ideally, this calibration must be done before and after the deployment. It is critical to find the correction of the sensor after deployment - especially for long deployments - because of the changes of the sensor during the deployment including sensitivity drift and biofouling effects. In order to account for the status of the sensor during the deployment, the recovered sensors must be calibrated before cleaning the fouling. They must be installed at the same height in the CTD frame with a good calibrated sensor to be compared with (e.g. SBE37 ODO sensors are usually adjusted through a dedicated CTD-rosette cast at 1000m depth during 30min).

## Nitrate calibration

It is recommended to calibrate the sensor previous to a deployment using a CTD cast. The nitrate sensor can be set in continuous mode at the frame and record values internally for the trial duration. Measurements should be calibrated against Total Oxidised Nitrogen measurements ( $\text{TON} = \text{NO}_3^- + \text{NO}_2^-$ ) from the Niskin bottles sampled at various discrete depths, according to the deployment depths. For PAP1 observatory, typical calibration depths are 5, 10, 20, 30, 40, 50, 60, 80, 100, 150 and 200 m.

Configuration of the sensor involves the sampling mode and rate and logging options. The values should consider the duration of the deployment and the life of the battery that is used to power the sensor.

## CO<sub>2</sub> calibration and configuration, FixO3 pCO<sub>2</sub> sensor inter-comparisons

One goal in FixO3 is to perform a longer deep-water pCO<sub>2</sub> sensor inter-comparison of the two technologies, pCO<sub>2</sub> optodes and ISFET based sensors, that can handle high pressure without special modifications. This work was started in June 2016 by deploying a mooring, at 2500 m at the IFREMER Antares site. This mooring carried an Aanderaa SeaGuard multi-sensor platform with a pCO<sub>2</sub> optode included, and two ISFET based pCO<sub>2</sub> sensors from Tokyo University.

Before this deep-water deployment a pre-evaluation was carried out in the form of a two-month inter-comparative deployment at shallow water at the cabled Koljoeffjord observatory, operated since 2011 by the University of Gothenburg, on the West Coast of Sweden (<http://koljofjord.cmb.gu.se>). FixO3 deals with underwater platforms hence we did not include any technologies that are limited to deployments from surface platforms (buoys and land based stations).

Overall the deployment included 14 different pH and pCO<sub>2</sub> sensors. The table below lists and compares the pCO<sub>2</sub> sensors that took part in this test. In the figure below the mooring frame that carried the sensors is described and further below some examples of results are given. A detailed report comparing the different sensors with reference data is available as a separate FixO3 report (contact Anders Tengberg, [anderste@chem.gu.se](mailto:anderste@chem.gu.se)).

To summarize the test for the pCO<sub>2</sub> sensors, there was important fouling of the frame at the end of the deployment, which affected the sensors that were not equipped with antifouling protection. Due to power cuts there was gaps in the data from some of the more power hungry sensors that were dependent on power from land. Before fouling affected the sensors they all displayed similar relative variations in this dynamic environment with natural pCO<sub>2</sub> oscillations from about 200-500  $\mu\text{atm}$  (see data examples below).

None of the sensors was consistently agreeing with the reference data that was obtained from frequent water samples during the deployment (see data examples below). Therefore, it is not possible to judge which sensor(s) were the most accurate in absolute terms. The NDIR based sensors had better initial calibrations but when the Optodes and ISFET sensors were adjusted with the first reference value they gave similar dynamic changes and noise level (precision).

Sensors with pumps, two NDIR sensors from PSI, can normally not be sampled with the same frequency as the other sensors and the readings from the pumped sensors seems reflect a larger water volume since water is drawn from the surroundings. This was more visible at the end of the deployment when the un-pumped sensors were more affected by local fouling on sensors and the mooring frame.



The response time of the tested sensors is relatively slow,  $t_{63}$  around 5-6 minutes which makes them challenging to use in applications where a fast response is required (e.g. for profiling).

Power consumption can be a serious impediment to longer deployments if reliable land power is not available. The  $p\text{CO}_2$  and ISFET sensors consume about 100 times less power than the other technologies.

Table 2.4.3.2a  $p\text{CO}_2$  Instruments used during the Koljo Fjord inter-comparison study

Instrument	Parameter; internal ref.; $t_{63}$ response time	Interval; pump; antifouling	Internal battery; power consumption	Data recovery
<b>Contros HydroC™ CO<sub>2</sub>; NDIR</b>	$p\text{CO}_2$ ; Yes 0 value; $t_{63}=6$ min	1 min; No; Cu Shield	No; 5-8 W	100 %, small gaps due to power cuts
<b>Aanderaa Seaguard®; Optode</b>	$2^*p\text{CO}_2, \text{pH}, \text{O}_2, \text{P}, \text{C}, \text{T}$ ; No; $t_{63}=5$ min	1 min; No; No*	Yes; 0.05 W for entire system	100 %, sensors affected by fouling at the end
<b>PSI CO<sub>2</sub>-Pro™ CV; NDIR</b>	$p\text{CO}_2$ ; Yes 0 value; $t_{63}=6$ min	30 min; Yes; Yes TBT	No; 5-8 W	100 %
<b>PSI CO<sub>2</sub>-Pro™; NDIR</b>	$p\text{CO}_2$ ; Yes 0 value; $t_{63}=6$ min	60 min; Yes; Yes TBT	No; 5-10 W	27 %, power cuts created overwriting of old data
<b>Franatech CO<sub>2</sub>; Solid-state electrolyte cell</b>	$p\text{CO}_2$ ; No; $t_{63}=\text{No}$ Data	1 sec; No; No	No; 7 W	50 %, data missing due to power cuts, noisy
<b>University of Kyushu; ISFET</b>	$2^*p\text{CO}_2$ ; No; $t_{63}=\text{No}$ Data	30 sec; No; No	No; 0.02 W	75 & 100 %, affected by fouling at the end

\* Cu tape normally used in other deployments for antifouling protection

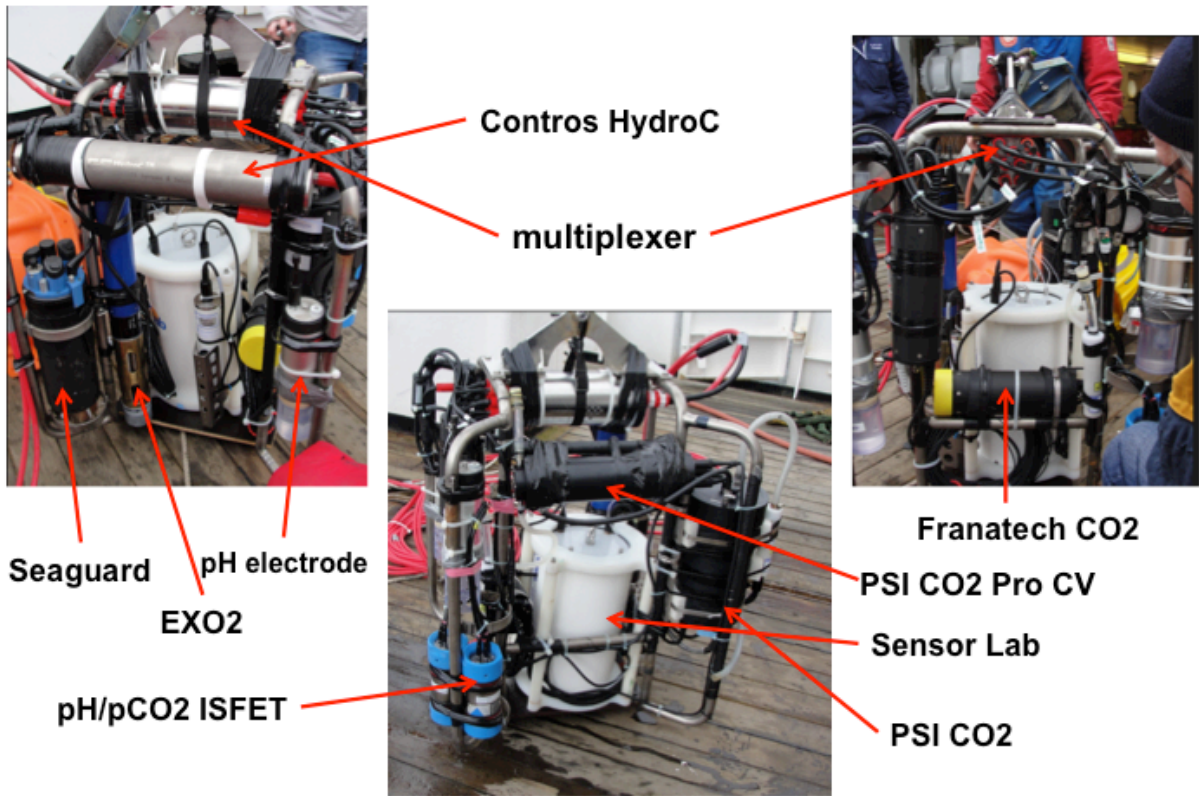

Fig.2.4.3.2a. The FixO<sup>3</sup> node with the sensors after assembling.

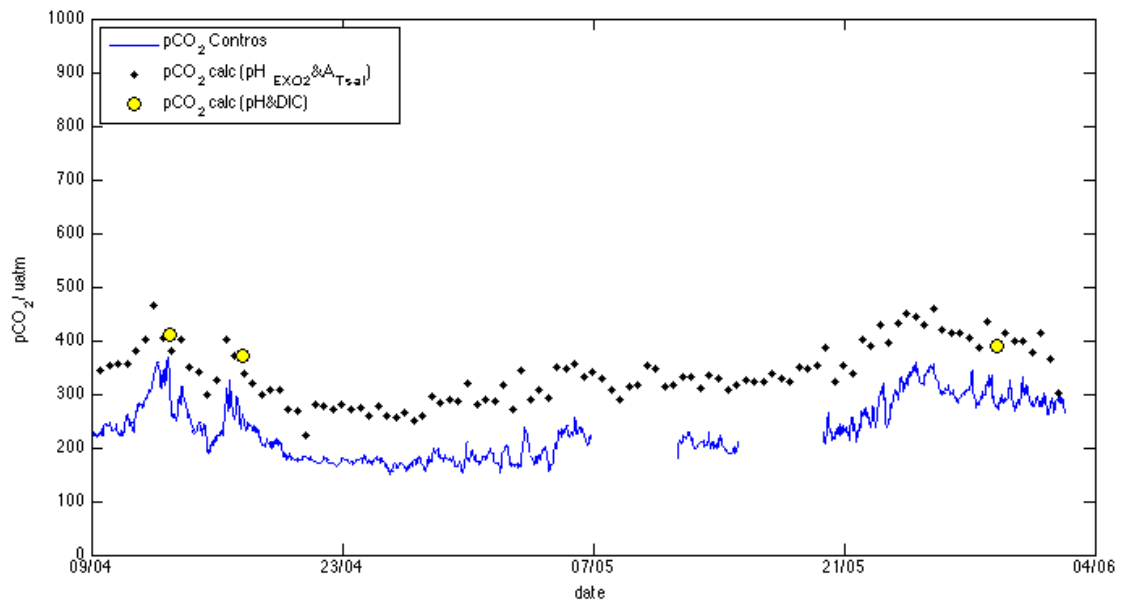

Fig.2.4.3.2b. Overview of pCO<sub>2</sub> data recorded with CONTROS HydroC™.

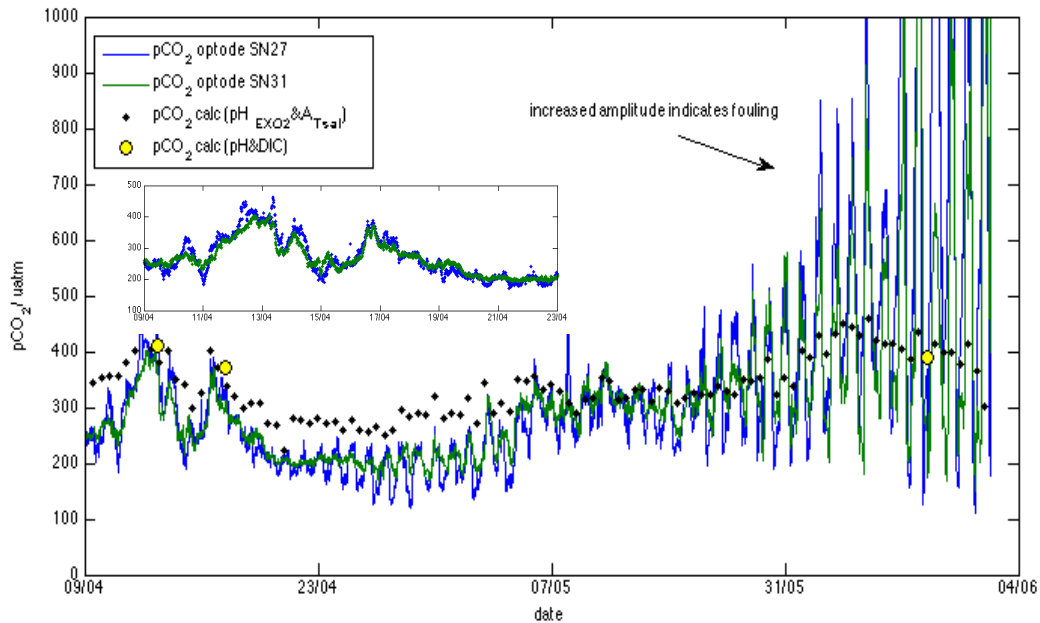

Fig.2.4.3.2c. Overview of  $p\text{CO}_2$  data recorded with Aanderaa  $p\text{CO}_2$  optodes. The insert is a blow-up of data from the first part of the measurement campaign.

### 3. Deployment and recovery (OGS, IFREMER, Univ. Aberdeen, UPC)

#### 3.1 Means

##### 3.1.1 Means for mooring and buoys

The deployment/recovery of oceanographic moorings, especially the deep ones located far from the coastline, require an adequate knowledge of the environmental conditions, both for choosing the vessel and planning the operations. Adequate naval mean and expert personnel (scientific, technical, and ship-crew) are essential in order to perform a successful work. The choice of the naval mean comes together with specific requirements, such as: length of the mooring line, maximum depth of the observatory, distance from land and number of people directly involved in the operations, number of instruments and weight of the buoy and of the ballast used as anchor for the mooring.

The last point is very important, because not all vessels are equipped with winches able to lift up weight larger than 1000-2000 kg. Moreover, the space offered by the ship on its stern has to be large enough to host surface buoys (Figure 3.1 a) for some days (the time required to complete the maintenance).



Figure 3.1 a: Oceanographic buoy recovery on the ship's stern during mooring maintenance procedures.

Possibly, and depending on specific activities, the vessel should also be equipped with two winches, to wind the mooring rope in the appropriate direction for the deployment. This is very important with mooring lines of several hundred meters.

Additionally, a small boat (ship's tender, such as a rubber boat) to operate close to the surface buoy, can be essential to minimize the risks of damage for the instruments, especially with rough weather conditions.

Well-equipped research vessels are of course the best choice to conduct such a complex maintenance procedures: additional instrumentation such as CTD-rosette system, precise positioning systems, dry and wet laboratories, multi-beam or large-range echo sounders, guarantee the highest quality and safety of the operations, particularly when the instruments used on the mooring line require specific quality control tests (e.g. CTD casts prior and after mooring recovery/deployment, water samples for data comparisons, etc.).

[1] Consideration should be given to using non-toxic materials for oceanographic mooring ballast. It is generally agreed that the environmental impact of leaving chain or concrete ballast on the seabed is minimal. As nearly all deep water (typically water depths greater than 200 meters) moorings are designed on the sub-surface single point principle that uses in-line instrumentation and acoustic releases to recover the mooring, it is very difficult to recover the ballast. Any significant change in mooring design or attempts to recover the ballast makes the deployment and recovery operation inherently more risky. This does not need to apply to moorings with a surface buoy and no sub-surface in-line instruments.

[2] Finally, the operations manager (e.g. chief scientist) and other accompanying personnel are normally responsible for the following:

- Assuring that all mooring components and support equipment are loaded aboard the ship as scheduled;
- providing all required service, repairs, or adjustments to the buoy, mooring, or payload as required;
- completing a thorough buoy inspection prior to the ship getting under way to assure the seaworthiness of the buoy;
- recommending proper deployment techniques to the captain of the vessel to reduce the risk of fouling the mooring in the propeller or damaging the buoy and its sensors;
- preparing a complete and accurate report of the operation including all pertinent test data and configuration control information, accurate documentation on the as-deployed mooring configuration, and any changes made to the existing mooring;
- assuring that safety of personnel is the primary factor controlling the operation.

[1] OGP – “HS&E guidelines for metocean surveys” - Report No. 348, December 2003  
<http://www.ogp.org.uk/pubs/348.pdf>

[2] DBCP – IOC-WMO – “Guide to moored buoys and other ocean data acquisition systems”, Meindl 1996  
<ftp://ftp.wmo.int/Documents/PublicWeb/amp/mmop/documents/dbcp/Dbcp8/DBCP-08-Guide-Moored-Buoys.pdf>

### 3.1.2 Means for seabed observatories

It is more than obvious that the existing equipment (submarines, remote operated vehicles (ROV), autonomous underwater vehicle (AUV), Hybrid ROV) available within the scientific community govern the early days of intervention procedures on underwater observatories.

Indeed, a direct transfer of methods of the offshore industry to the installation of underwater scientific modules could be detrimental to the scientific community in terms of equipment availability and installation costs. As opposed to the offshore philosophy which offers no compromise to equipment performance, a more flexible approach should be taken by the scientific community by evaluating performances of alternative methods such as smart rigging and lower cost of the support ships, versus sea state capability and global cost.

Concerning the main cable for cabled observatories, it is more than likely that planning, installation, and future maintenance will be committed to commercial submarine telecommunications systems and specialized survey companies that make use of existing and proven commercial hardware, jointing, methods and techniques. So the project cycle for a scientific system will largely follow the standards of these companies and the steps of commercial undersea cable systems.

However, scientific submarine cable systems impose different requirements for route survey data. The most scientifically interesting sites on the seabed tend to be those sites that pose the most difficulty to the cable route engineer for ensuring the long term integrity of the deployed cable. In these cases, project schedules can be improved and costs lowered by making use of existing and extensive seabed data from past experiments conducted at well-established sites of scientific interest.

Due to the smaller size of the modules to deploy in scientific missions compared to offshore industry, and the deliberate choice to do the operation by good sea conditions, with stand by acceptance, lifting operations are generally conducted with no highly specialized ship, even sometimes with small oceanographic vessels.

Different experiences exist, with different vessels, module size, depth and deposit requirements, company crew experience and rules.

Each deployment is specific, but there are some rules or experience’s results that can be underlined:

#### 3.1.2.1 Weather conditions and dynamic loads

Considering that some scientific operations will not be achieved with highly specialized vessels, with no active heave compensation systems, the cable deployment operations will be done by sea-state level three maximum. In some cases, Active Heave compensation systems can be replaced by passive systems or by smart rigging arrangement, allowing the uncoupling of dynamic loads from surface support before landing on seabed.

#### Positioning system

For all these operations, a precise acoustic positioning system (LBL or SBL) is essential. Combined with a transponder on the extremity of the cable, the deposit precision can be metric.

### *3.1.2.2 Dredger line and fishing tail on the bottom*

A cost effective solution for module recovery by cable, is to connect to the module (can be prepared on the equipment before landing, or placed by a ROV before recovery operation) a specific “fishing tail”, that can be dredged directly from the ship by a recovery line equipped with grapnel. This technique needs a good positioning system, with a transponder on the line and on the grapnel. A “dredging area” have to be defined, where there will be no scientific installations, or these will be in safety position before operation. The fishing tail will not be longer than 30 m, to ease the recovery surface operation. This operation must be achieved by very good weather conditions, in very low ship displacement. It can take a few hours (experience between two and eight hours).

### *3.1.2.3 Precise orientation with ROV assistance*

Placing the load at a correct compass heading, may be necessary. In this case the use of passive methods, like orientation panels or anchorage line, is not considered as reliable.

The operation needs the intervention of an ROV, in coordination with deposit operation. During all the operation there are two cables underwater, close from each other. This is currently operated by offshore companies although not accepted by some ship owners or captains (example of Neptune Canada deployment). The company and the operational crew must have well tested the operation. Safety procedures will be planned, with completely separated safe energy sources for lifting devices and ROV deployment. The operation will be done by Dynamic Positioning (DP) vessels, with good weather conditions. Additional care should be taken to avoid entanglement with the ROV umbilical or tether. The two cables will have to be as similar as possible (diameter and torque properties). It is recommended that the two main lines (lift line and ROV umbilical) be deployed from separate areas of the intervention vessel. The distance between the two cables have to be as great as possible depending on the vessel performances, and with a minimum of 15 m. The lift line should be heave compensated, especially from small heave-prone intervention vessels. Compensation includes an active heave-compensated crane or configuration of the lift line in a lazy S, located mid depth, using buoyancy cells to isolate heave motions from load movement below.

### *3.1.2.4 Direct use of the ROV to deploy and orientate ocean bottom subsystems*

The deployment of small ocean bottom subsystems, in the frame of the buoyancy and payload of a ROV with “Free Fall Mode” deployment. Concerning deployment of heavy ocean bottom subsystems directly by ROV, there are some good experiences. The example is illustrated by the Canadian Scientific Submersible “Ropos”. The system in a mid-depth configuration (up to 2500m) has been successfully used to recover instruments weighting in excess of 2000 lbs and is a backbone of the ROCLS (Remotely Operated Cable Laying System for NEPTUNE). In that configuration it uses a 14 tons launch and recovery system (LARS) and a 15 Tons direct umbilical, with a crane using a passive heave compensation mechanism. Provided the vessel can hold station, ROV operations can be achieved in sea states 5.

## **3.2 Deployment- recovery procedures**

Deployment-recovery procedures should start with the definition of a complete **Field Service Plans (FSPs)**. The FSP defines the nature of the work to be accomplished and include the necessary equipment lists, specific mooring diagrams, and logistics requirements. FSPs should normally be prepared well in advance of a maintenance mission and provided to both field service personnel and the supporting vessel. Before any operations at sea, FSP have to

be communicated to the local Marine Service in order to obtain the necessary permissions for the operations. Once on board, the FPS should also be illustrated to all scientific and technical people on board, defining the role of each person involved in the operations. Indeed, when the recovery/deployment operations start, there is no more time to explain what to do to not expert people, especially if the operations are done during rough sea conditions. Defining a complete FSP is very important to reduce the risk of damage to the mooring's instrument and accident to the people involved in the operations.

### 3.2.1 R/V operations

Briefings by the mooring/buoy center personnel or EMSO observatory "Regional team" or other FixO3 operational team prior to sailing are necessary in planning the vessel's itinerary, the work plan, and the list of operations that must be followed during the cruise, taking into account also the possible days of bad weather.

When a new buoy station/mooring line has been established or a new mooring deployed, the exact position of the anchor needs to be determined. It usually takes 20 to 45 minutes for the buoy to settle on its mooring following release of the anchor. Each time ground truth is taken, the ship's position together with the range and bearing to the buoy are passed back to the center and FixO3 data management system. This information can be used along with buoy position-fixing systems to determine the position of the anchor for the Notice to Mariners.

### 3.2.2 Tests prior to deployment

Prior to deployment a set of tests should be carried out on the observatory infrastructure to verify the proper operation of sensors and compatibility with the observatory. The complete procedure will be defined by the target observatory but the following items should be at least considered [1]:

- It is essential to ensure that instruments are prepared and set-up in accordance with the manufacturer's guidelines. All instruments should also be serviced with appropriate audit material.
- Instruments should be wet-tested (where possible) to full depth prior to deployment to ensure that water-tight seals are not compromised. If appropriate, scientific instruments should be calibrated before deployment in their mounting brackets e.g. compass calibration. Auxiliary instrumentation such a self-recording CTD should be calibrated using the high precision CTD/Rosette taking into account the longer response times of the self-contained CTD thermistor.
- Prior to instrument set-up, the computer which is used to set-up the instruments should have its time corrected to GMT/UTC. This will then feed into each of the instruments (which typically correct themselves to the computer's clock) and ensures that measurements are concurrent between units.
- Following set-up of the instrument with the survey data recording settings, it is recommended that acoustic instrumentation start data collection prior to deployment. By doing so, it is possible to check that the instruments are working prior to deployment through electrical and acoustic interference of an analogue radio.
- Where instruments are set-up using a communication link which provides mains power to the unit, checking that the instrument is working provides the survey crew with the confidence that the unit's battery power supply has not been compromised.
- All lifting points and lifting equipment (including shackles, wire ropes and slings) should all be visually inspected.
- Depending on the ships layout and configuration it is normal to build the mooring on the deck and wind onto a "net drum" with insertion points for instruments. This is essential for long or full depth moorings where several kilometers of rope or wire will

be used. Shorter and shelf seas moorings can be “flaked out” on the deck and instruments/floatation directly attached.

- Once on site, the depth should be confirmed by echo sounder with that used in planning using the corrected local speed of sound. It is also good practice to test the acoustic releases at full water depth.
- It is suggested that one member of the survey team checks over all of the instruments and mooring to ensure that shackles are connected in the correct place, all blanking plugs are in the correct ports on instrumentation, that instruments are switched on and working. To assist this process, it may be worthwhile having a checklist which can be checked off with serial numbers, dates/times and mooring diagram.
- Once deployed, the surface marker or spar buoy should be checked to ensure that it is riding correctly with the planned freeboard.

[1] *Premiam - Technical Guideline No. 06– “Deployment of current meter moorings “- James Parker and Jon Rees*

### 3.2.3 Deployment procedures

For the offshore deployment the following basic procedure should be followed:

- A. Preparation and review of all the instrument parts including brackets and anchoring parts and boxing for safety transportation to the vessel.
- B. Installation briefing with divers team or ROV pilots, vessel captain and instrument responsible.
- C. Instrument and data receiving system commissioning coordinated with shore station team to verify correct assembly.

After the deployment the instrument will be included in the observatory maintenance program that should include continuous monitoring of instrument environment (internal temperature and humidity, supplied voltage, consumed current, etc.), regular visual inspections and manual cleaning if required.

The following samples provide hints for development of deployment checklists that suggest ways to ensure QA by using specific procedures and techniques [1]:

#### *Pre-deployment QA checklist*

- Read the manual.
- Check that validation in simulated conditions (pressure, vibration...) has been performed (see Esonet Label) either by the manufacturer or by the instrument owner.
- Establish, use, and submit (with a reference and version #) a documented sensor preparation procedure (protocol). Should include cleaning sensor according to the manufacturer’s procedures.
- Calibrate sensor against an accepted standard and document (with a reference and version #).
- Compare the sensor with an identical, calibrated sensor measuring the same thing in the same area (in a calibration lab).
- View calibration specifications with a critical eye (don’t presume the calibration is infallible). Execute detailed review of calibrated data.
- Check the sensor history for past calibrations, including a plot over time of deviations from the standard for each (this will help identify trends such a progressively poorer performance). Control chart calibrations.
- Check the sensor history for past repairs, maintenance, and calibration.



- Consider storing and shipping information before deploying.: heat, cold, vibration, etc.
- Provide detailed documentation.
- Record operator/user experiences with this sensor after reading the manual.
- Search the literature (especially from FixO3 community) for information on your particular sensor(s) to see what experiences other researchers may have had with the sensor(s).
- Establish and use a formal pre-deployment checklist.
- Ensure that technicians are well-trained. Use a visual tracking system for training to identify those technicians who are highly trained and then pair them with inexperienced technicians. Have a data quality review chain.

### **Deployment checklist**

- Scrape bio-fouling off platform.
- Verify sensor serial numbers.
- Deploy and co-locate multiple sensors (attention to interference if too close).
- Perform visual inspection; take photos if possible (verify position of sensors, connectors, fouling, and cable problems).
- Verify instrument function at deployment site prior to site departure. Allot sufficient time for temperature equilibration.
- Monitor sensors for issues (freezing, fouling).
- Automate processing so you can monitor the initial deployment and confirm the sensor is working while still on-site.
- Specify date/time for all recorded events. Use GMT or UTC.
- Check software to ensure that the sensor configuration and calibration coefficients are correct. Also check sampling rates and other timed events, like wiping and time averaging.
- Visually inspect data stream to ensure reasonable values.
- Compare up and down casts and/or dual sensors (if available).
- Note weather conditions and members of field crew or when available, document the cruise reporting software.

### **Post-deployment checklist**

- Take pictures of recovered sensor as is for metadata.
- Check to make sure all clocks agree or, if they do not agree, record all times and compare with NIST.
- Post-calibrate sensor and document before and after cleaning readings.
- Perform in-situ side by side check using another sensor.
- Provide a mechanism for feedback on possible data problems and/or sensor diagnostics.
- Clean and store the sensor properly or redeploy.
- Visually inspect physical state of instrument.
- Document the sensor registry in the database.
- Verify sensor performance by:
  - Checking nearby stations;
  - Making historical data comparisons (e.g., long-term time-series plots, which are particularly useful for identifying long-term bio-fouling or calibration drift.)

### 3.2.4 Recovery procedure

For the instrument recovery, a similar procedure must be followed:

- A. Instrument software shutting down and electrical switch off.
- B. Instrument recuperation by vessel and diving/ROV team.
- C. Graphical documentation of the equipment status as it gets.
- D. Retrieval of data stored in the instrument memory.
- E. Operational check and after deployment calibration test.
- F. Deep cleaning.
- G. Packing and storage or return to the owner.
- H. Writing a deployment report and storage of the entire acquired data set.

## 3.3 Inspection/maintenance (servicing)

### 3.3.1 ROV operations

ROVs may be used at observatories for purposes of site inspection, module lifting and lowering, cable laying, underwater connections as well as inspection and maintenance works. The different types of ROV include Observational ROVs (Class I), Observational ROVs with Payload Option (Class II), Work Class Vehicles that carry additional sensors and/or manipulators (Class III), Towed and Bottom Crawling Vehicles (Class IV) and Prototype and Development Vehicles (Class V). The capabilities of the ROV(s) available for use at a platform will dictate the intervention procedures. There are number of offshore industry standards that can be implemented or adapted for scientific use. For example, the API recommended practice 17H (Remotely Operated Tools and Interfaces on Subsea Production Systems) [1] provides recommendations for the development and design of remotely operated subsea tools and interfaces. Additional guidance on the selection, design as well as the operational requirements for maximising the potential of standard equipment can be found in ISO 13628-8:2002 (Remotely Operated Vehicle (ROV) interfaces on subsea production systems) [2]. Any modules requiring manipulation by an ROV should have clearly identifiable grasping handles, docking points and torque tool receptacles (Figure 3.3.1 a). The aforementioned industry standards API 17H and ISO 13628-8:2002 outline the mechanical and electro-hydraulic standards for ROV panels.

Additional industry guidelines include the NORSOK standard [3] which aims to produce a single common standard for ROV operations and the International Marine Contractors Association (IMCA) Remote Systems & ROV Division also has a number of publications offering guidance on many aspects of ROV operations, including their safe and efficient operation [4]. Risk assessments and operating procedures should be clearly documented and a defined chain of command identified for any unforeseen event.

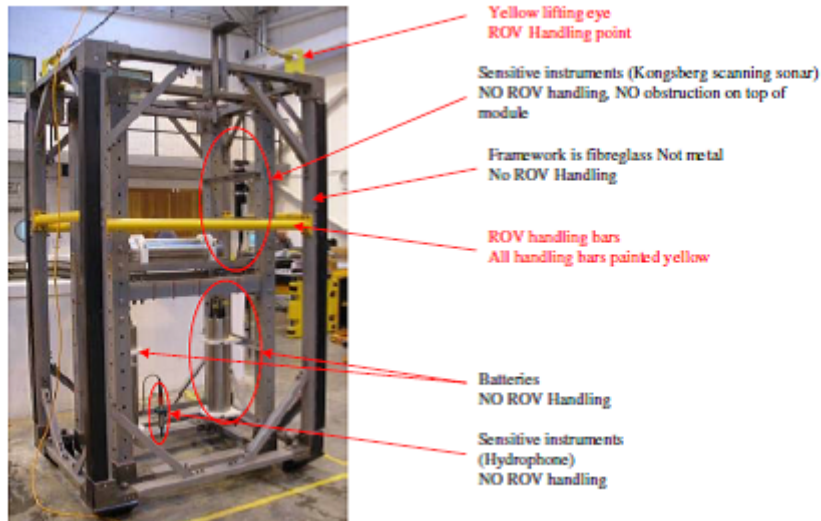

Figure 3.3.1 a: Except from the DELOS Servicing Procedure manual indicating safe ROV handling points of a module containing scientific instruments.

In some cases, an ROV may be instrumented to provide additional measurement of parameters of interest. These sensors include still and video cameras, oceanographic sensors, side scan sonar etc. During servicing an ROV is usually deployed at a safe distance from the platform location. Cameras on the ROV can be used to perform a visual inspection or survey of the seafloor around the site, thus enlarging the spatial extent of the observatory time series. Regular mapping is recommended at various scales: acoustic map detailed by optical mosaicking. A visual inspection should also be carried out of the platform to identify any damage or corrosion issues. Bulls eyes mounted on the platform can also be used to assess any inclination in the platform since last service and after any servicing procedure.

[1] API 17H Remotely Operated Tools and Interfaces on Subsea Production Systems, Edition 2, June 2013, PRODUCT NO.G17H02

[2] ISO 13628-8:2002 Petroleum and natural gas industries: Design and operation of subsea production systems: Part 8: Remotely Operated Vehicle (ROV) interfaces on subsea production system

[3] U-102 Remotely operated vehicle (ROV) services (Edition 2, September 2012)

[4] IMCA R 004 Rev. 3 Code of Practice for The Safe & Efficient Operation of Remotely Operated Vehicles (2009)

### 3.3.2 Divers operations

Regular inspections and maintenance services are critical to achieving a long service life of ocean moorings. In some cases, when the buoy/mooring are located in shallow water, or when the instruments are deployed few meters below the surface, divers inspections and/or maintenance operations can be useful. Specialized teams tailored inspection and maintenance programs covering mooring lines, connection points, netting and equipment assemblies. Testing services include break strength and abrasion analysis for nets and rigging, and fatigue service life assessment for parts, assemblies and attachments. Divers operation on buoys and moorings in the open seas are very limited by safety rules.

## 4. Post-deployment procedures (CNRS, IEO, CNR, INGV)

### 4.1 Data transfer

Several methods can be used for data transfer. The system used to do so is heavily dependent on platform type, location, economic cost, power consumption and desired frequency.

For this purpose, one (or more if the transmission system is redundant) can be adopted:

- **Satellite:** this system can be considered “universal” as satellite has worldwide coverage, avoiding the platform location issue. This system is also very reliable, but since satellite transmission is normally paid based on bandwidth consumption it can be very expensive or limit the amount of transmitted data.
- **Radio:** the benefits of using this system are they low power consumption and the almost unlimited amount of data that can be transferred. Con for this system is that you need a line of sight or repeaters in order to be able to transfer data. It has to be taken into account that two different band types of radio frequency can be used, free or licensed band. Free band is accessible to everybody, but since everybody can make use of this part of the radio electric spectrum you may face interferences, even leading in data loss. The use of licensed band is restricted so interference is avoided, but payment may be required. Usually for research purposes it is free of charge, but this is country legislated so contacting your country radio electric spectrum control managers is a must.
- **Mobile broadband:** the development of 3G/4G networks facilitates the access to these technologies for data transmission. Quite robust, reliable and affordable, its main limitation is the geographic availability, where in off shore observatories the coverage of this network is practically zero.
- **WiMAX:** belongs to the 4G technological family and as the more known Wi-Fi allows wireless communication between two devices through electromagnetic waves. The maximum speed and range of the WiMax connections depend on the version of the standard used in accordance with the IEEE 802.16 family of standards. The latest version, known as WiMAX IEEE 802.16m or WiMAX Release 2.0, allows theoretical speeds of up to 1 Gbit/s for users in fixed locations, and 365 Mbit/s for mobile users. The theoretical range goes from 15km for mobile users to 50km for users at fixed locations. These are theoretical maximum speeds and ranges and the actual maximum depends on the number of users simultaneously connected to the same access point and other factors, which make download speeds and real ranges in practice tend to be lower than the theoretical maximum. With high transfer speeds, the main handicap for this solution to be adopted is its range since many observatories are placed further than the actual range. The link between observatory buoy and ship of opportunity is a good solution to avoid disturbing the buoy and transmit more data than satellite communication link. A dedicated task was planned by FixO3 proposal but cancelled during the negotiation after budget reduction.
- **Undersea cable:** this is the most robust solution but also probably the most expensive and difficult to implement. It also allows an almost unlimited bandwidth, but installation and maintenance is a long process since for long cable runs the price is prohibitive and environmental issues may arise in any cable length, requiring permission from authorities. EMSO has addressed these topics. This will be limited to sites of high interest where multidisciplinary arguments converge to a consensus on site definition.

#### 4.1.1 Real time versus delayed mode

Even if the real time data transmission is more expensive in term of communication (iridium), sensors technology (induction system, modems installation) and mooring design, it presents obvious advantages compared to the delayed mode acquisition. The most important are listed here:

- Data are saved in case the observatory cannot be recovered
- Feedback about buoy and sensors: QF attribution allow to identify rapidly the data quality
- Engineering data: battery level, amount of data acquired are known, biofouling
- The two-way telemetry: the iridium communication allow to change sensor configuration as sample rate for dedicated experiments (e.g. bloom start, mixing deepening, ...)
- Collect events such as threshold reached for some parameters

It can be also used to survey the progress of the data acquisition:

- The quantity of received data allow to check if sensors are functioning correctly and regularly
- Two-way telemetry system: can configure the observatory if any issues are observed (e.g. low batteries, biofouling...)
- Gather engineering data: power, sensor, H&T, buoy position, etc....
- Regular maintenance: allow to set up intervention on observatory if any issues occurred

#### 4.1.2 Data post processing

Once the sensors are recovered, data should be processed and qualified for scientific applications. The real time transmission by some observatories is helpful to anticipate these tasks. To check the quality of the sensors acquisition, regular CTD casts need to be performed along the whole water column before and after their deployments. Usually, mooring/buoy sensors are deployed on CTD-rosette frame during a dedicated cast where physical and biogeochemical processes variability are low (e.g. 1000m during 30min). Then, the CTD data can be compared to observatory sensors. For biogeochemical data, Niskin sampling are also recommended (e.g. dissolved oxygen, nitrate, phytoplankton pigments, dissolved inorganic carbon, ...). Finally, during the data process, the sensors clock drift has to be checked and identify (universal time). During ROV recovery of EMSO observatories, reference sampling and measurement must be performed in a similar way.

After the sensors recovery and data processing, we recommend to send the sensors to calibration facilities for post-calibration procedures (e.g. every 2 years for TS sensors). The post calibration coefficient is then used to adjust the processed data (adjustment of the data drift between the two calibration period).

The cleaning immediately after use and maintenance procedures have to be observed carefully. Each procedure depends on the sensors type and we recommend to follow the sensor manuals distributed by the manufacturers. In addition, inter-comparison exercises can be performed between different labs in order to check the robustness of the sensors acquisition.

Finally, all information described here should be assigned in the metadata list in addition to the QF codes designation.

## 4.2 Emergency procedures

Sometimes, emergency procedures need to be performed during the observatory deployment. For example, unexpected early buoy recoveries have to be done. After the recovery, it is essential to examine the system components and to modify items where weaknesses had been exposed. For example, the data hub housing leaked for two deployments, CTD cables connecting into the buoy had both failed in the two previous deployments, etc....

These operations are manpower consuming but they are necessary if we want to maintain long term observatory with limited data gaps.

## 5. Quality control procedures and data correction (CNRS, GEOMAR)

The primary objective of any ocean observing infrastructure is the acquisition of sensor data which in turn is used to provide information about relevant ocean variables (e.g. salinity, alkalinity, particulate organic matter, Chlorophyll-a concentration) for ocean system understanding as well as for monitoring. The data that is delivered by a sensor requires certain procedures for its conversion into an ocean variable. The procedures must consider two basic expectations:

1. Quality control according to defined standards (or alternatively proper documentation of new standards)
2. Quantification of data quality (e.g. standard error, error distribution)

Only if both expectations are addressed the derived variables can be used to quantify, describe and assess the oceanic environment. Moreover, any use of data within a network approach, that is merging information from one infrastructure with observations of other networks, requires the two data quality procedures to be applied. For example, a chlorophyll-a observation from a glider that surveys the waters around a FixO3 mooring can only be merged with the single depth mooring data if the parameter “Chlorophyll-a” derived from sensor data at the mooring is similar to the “Chlorophyll-a” derived from a maybe very different sensor data that comes from the glider. In order to protocol the quality control we follow the OceanSITES recommendations outlined in the “OceanSITES User’s Manual” available from their website ([www.oceansites.org](http://www.oceansites.org)).

Similar processes of quality control are used by other disciplines of ocean science active in FixO3. The principles presented in this chapter are similar and under implementation by projects such as EMODNET and SeaDataNet. EMSO is supporting these processes.

### 5.1. Quality control

#### 5.1.1 Quality flag

For quality control flagging the concept as being worked out by the Data management team of the international OceanSITES initiative is applied (table below).

Table 5.1.1a OceanSites quality flags signification

Code	Meaning	Comment
0	Unknown	No QC was performed
1	Good data	All QC tests passed.
2	Probably good data	
3	Potentially correctable bad data	These data are not to be used without scientific correction or re-calibration.
4	Bad data	Data have failed one or more tests.
5	-	Not used
6	-	Not used.
7	Nominal value	Data were not observed but reported. (e.g. instrument target depth.)
8	Interpolated value	Missing data may be interpolated from neighbouring data in space or time.
9	Missing value	This is a fill value

### 5.1.2 Processing level

Based on the OceanSITES User's Manual the quality control and other processing procedures applied to all the measurement of a variable must also be set and protocolled as a value in the data structure. string values (in the 'Meaning' column) are used as an overall indicator (i.e. one summarizing all measurements) in the attributes of each variable in the processing level attribute.

Table 5.1.1a Processing level codes

Code	Meaning
0	No QC performed
1	Ranges applied, bad data flagged
2	Data interpolated
3	Not used
4	Not used
5	Data manually reviewed
6	Data verified against model or other contextual information
7	Other QC process applied

## 5.2 Data correction

The objective here is to address the most common data qualification methods used for physical and biogeochemical data acquired from autonomous sensors installed on fixed stations. These qualifications should be applied in post-deployment procedures (second level correction) in order to correct drifts and to qualify dataset. For physical data (pressure, temperature, conductivity and currents), a first review has been presented in 2005 with all Q/C procedures by Kartensen et al. 2005 (ANIMATE report). These procedures are still relevant and should be used as best practices for mooring sites.

In this paragraph, we focus essentially on correction methods that should be applied for biogeochemical essential climate variables recently implemented in observing system as FixO3 (oxygen, nitrate, pH, pCO<sub>2</sub>). The advantage of fixed stations versus Argo floats and gliders is the opportunity to perform robust comparison with in situ samples collected near the moorings when recurrent ship visits are possible. If regular ship visits are not possible, the use of climatology dataset near the fixed stations is also possible under steady state conditions (e.g. deep waters, no mixing zone, and low concentration level).

Table 5.2a Sensors capacity in the FixO3 stations network

Variables	Type of sensor	Range	Accuracy
Temperature	SBE37	-5 to 45 °C	± 0.002 °C
Conductivity	SBE37	0 to 7 S/m	± 0.0003 S/m
Currents	Aquadopp, Seaguard RCM	0 to 3 / 0 to 0.3 m.s <sup>-1</sup>	±1 % / ± 0.05 %
Dissolved oxygen	Optode 4330, SBE63	0-150 %/120 % saturation	± 8 µM / 3 µM
Chl-a	ECO FLNTU, Turner Cyclops	0-50 µg/l Chla	0.025 µg/l Chla
Nitrate	ISUS, SUNA	0.5 to 2000 µM/3000 µM	± 2 µM
pCO <sub>2</sub>	Contros, Pro-Oceanus, Aanderaa	0 to 1000 ppm / 0-600 ppm	± 4 ppm / 2 ppm
pH	SeaFet, SP101-SM	6.5 - 9.0 pH	0.05 pH/ 0.005 pH
Acoustics (passive)	SQ42	50-180 dB	3 dB

### 5.2.1 Oxygen data correction

Today, thanks to the Argo community efforts, oxygen qualification from optical sensors (optode) has improved especially due to the new calibration procedure performed by the manufacturers (multi-points calibration and Stern-Volmer equation). However, it is still admitted by the scientific community that the optode deployment always presents an offset around 20 µmol/kg. To correct this offset, we recommend using the last method from Takeshita et al. (2013). This linear method allows us to determine the slope and offset coefficients estimated from in situ sampling (Winkler titration) or climatology dataset (World Ocean Atlas). In sensitive oceanic regions, where seasonal variability is significant, we recommend to use in situ sampling as reference measurements (before mooring deployment and collection).



An example of calculations for the optode 3830 has been detailed here:

$$DOXY [\mu\text{mol/kg}] = C_0 + C_1DPHASE + C_2DPHASE^2 + C_3DPHASE^3 + C_4DPHASE^4$$

$$\text{with } C_i = C_{i0} + C_{i1}T + C_{i2}T^2 + C_{i3}T^3$$

and  $DPHASE = BPHASE$  (blue light) considering  $RPHASE = 0$  (red light)

This equation needs 20 sensor-dependant coefficients and calibration at this time was performed with two points calibrations (0 and 100% saturation).

The more recent optode 4330 (faster time response) offers more accurate oxygen concentrations but with more complex equations:

$$\Delta p = C_0 \times T^{m_0} \times CalPhase^{n_0} + C_1 \times T^{m_1} \times CalPhase^{n_1} + \dots + C_{27} \times T^{m_{27}} \times CalPhase^{n_{27}}$$

$$Air\ Saturation(\%) = \Delta p \times 100 / [(Nom\ Air\ Press - p_{vapour}(T)) \times Nom\ Air\ Mix]$$

$$DOXY [\mu\text{mol/L}] = [C^* \times 44.614 \times Air\ Saturation] / 100$$

with  $CalPhase = f(Tphase)$  and  $TPhase = C_1Phase - C_2Phase$  (blue-red light)

This equation used 27 calibration coefficients and was reduced to 7 coefficients from Stern-Volmer equation taking into account the pressure and salinity compensation (Uchida et al. 2008, Bittig et al. 2012, Asaro& McNeil, 2013):

$$DOXY [\mu\text{mol/L}] = [(C_4 + C_5 \times T) / (C_6 + C_7 \times TPhase) - 1] / [C_1 + C_2 \times T + C_3 \times T^2]$$

Since 2012, Aanderaa (XYLEM) performs a multipoint calibration method for the new optode in order to improve accuracy of  $C_i$  and DOXY precision (40 calibration points). However, after some tests, an offset of oxygen is still observed.

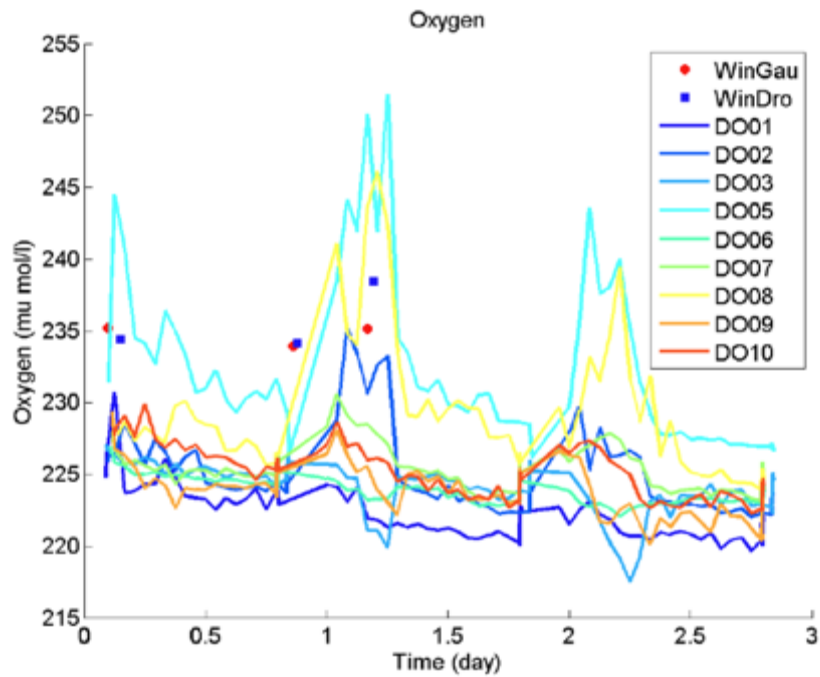

Figure 5.2.1 a: Oxygen measurements through optodes 4330 mounted on Argo floats. The line colors represent the different floats deployed over 3 days in pool for testing. The dots represent the Winkler in situ sampling. The mean difference between optodes on floats and Winkler values ranged around 5-12  $\mu\text{mol/L}$ .

Once the optode measurements have been done, it is recommended to proceed to some corrections. Two methods are usually proposed:

- adjusting the calibration coefficients by using a polynomial fitting model (in situ Winkler or WOA climatology or pO<sub>2</sub> in air are used as oxygen reference value)
- simple linear method to estimate the offset and gain (slope) of oxygen data (Takeshita et al., 2013).

$$DOXY_{adj} [\mu\text{mol/L}] = \text{offset} + \text{gain} \times DOXY [\mu\text{mol/L}]$$

The second method proposed here is easier and any modifications of calibration coefficients are necessary. However, a large amount of in situ or climatology data is required to guarantee the robustness of the optode correction.

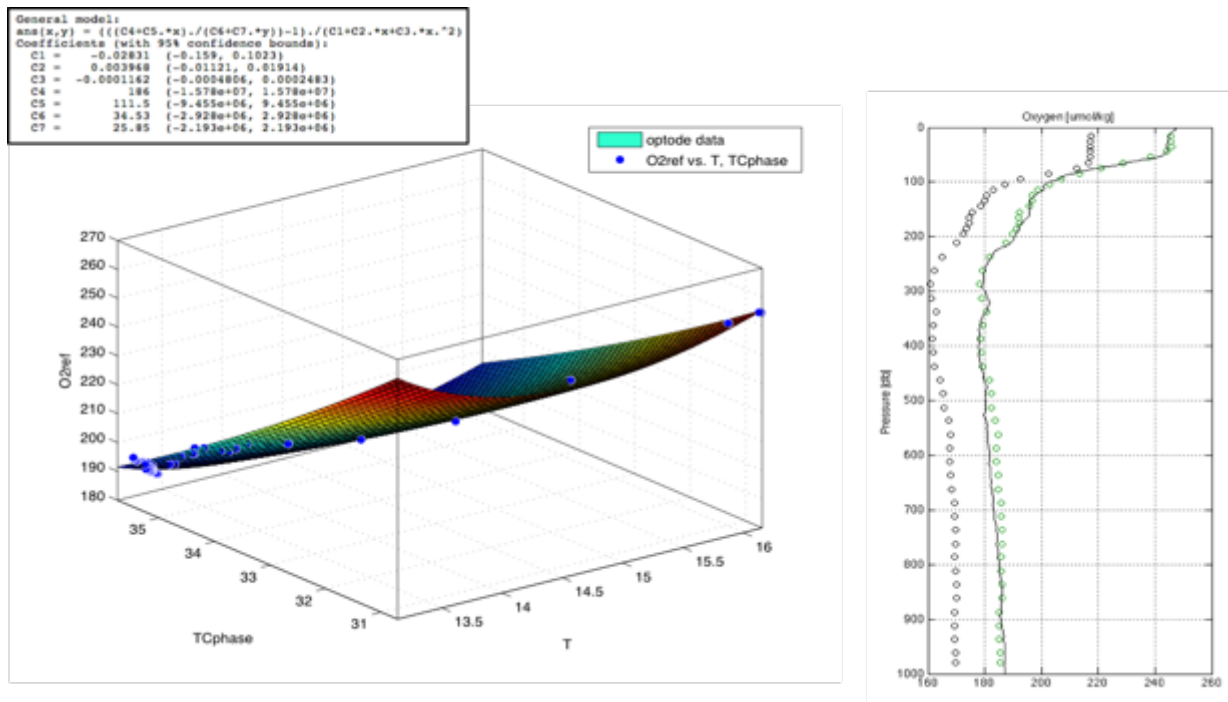

Figure 5.2.1 b: Example of polynomial fitting model used to adjust the calibration coefficient of optode (left panel). To perform this adjustment in situ profile at the deployment is needed (right panel)

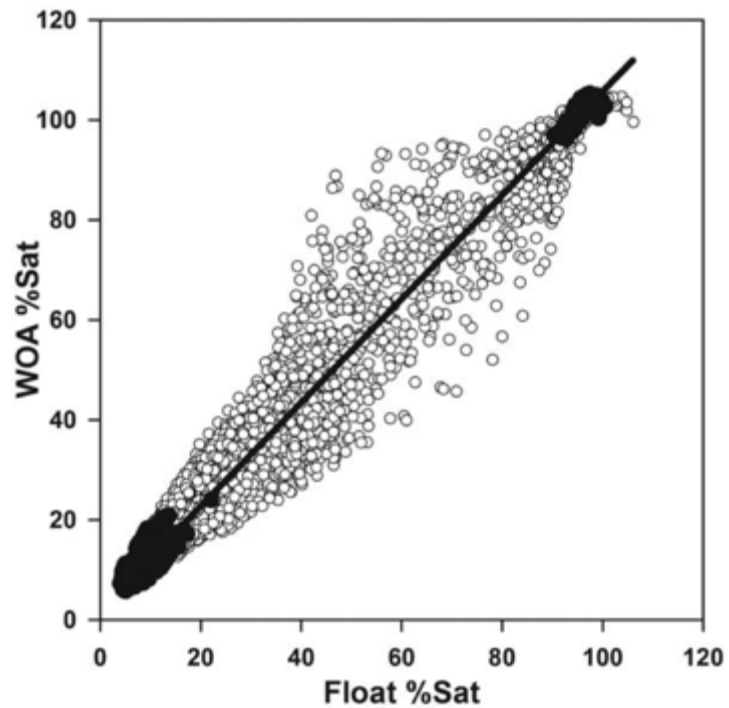

Figure 5.2.1 c: Oxygen saturation measured from optode (floats) compared to oxygen climatology dataset from Takeshita et al. 2013 (WOA climatology comparison is not working in high latitudes areas).

### 5.2.2 Nitrate data correction

The nitrate concentrations ( $\text{NO}_3$ ) in seawater can be obtained from optical sensors by using UV absorption technology (e.g. ISUS, SUNA, Johnson and Coletti, 2002). Currently, several methods are available for the deconvolution of the  $\text{NO}_3$  from the observed spectrum. The most widely used is the Temperature Compensated Salinity Subtracted (TCSS) algorithm which take into account the observed salinity and subtracted to the total absorbance and a temperature-dependant correction of seawater extinction coefficient (Sakamoto et al. 2009). Recently, a Temperature Compensated Salinity Subtracted (TCSS) algorithm has been developed for the deconvolution of nitrate concentration from the observed spectrum, taking into account the observed salinity and subtracted to the total absorbance and a temperature-dependant correction of seawater extinction coefficient (Sakamoto et al. 2009).

$$A(\lambda) - S \times ESW_{tis}(\lambda) = \text{NO}_3 \times ENO_3(\lambda) + \alpha_1 + \alpha_2 \times \lambda$$

$S \times ESW_{tis}(\lambda)$  = seawater absorption with T correction

$\text{NO}_3 \times ENO_3(\lambda)$  = nitrate absorption

However, this method is sensitive and problematic in the Mediterranean Sea where low  $\text{NO}_3$  (0-9 $\mu\text{M}$ ) and high salinity content (37-38.6) are observed (D'ortenzio et al., 2012; Pasqueron de Fommervault et al. 2015). Recently, an improved algorithm was developed and substantially improved the  $\text{NO}_3$  estimation in the Mediterranean Sea (Pasqueron de Fommervault et al., 2015). Major changes in the algorithm are:

1. Treating the wavelength offset ( $wl$ , see Sakamoto et al., 2009 for details) as a tuneable parameter (Johnson, 2014): correction of bias in  $\text{NO}_3$  above about 20°C
2. Considering the vertical lag between the CTD and the  $\text{NO}_3$  sensor (only in the case of the SUNA) by interpolating T and S at the depth of the SUNA (~ 1.5m): spikes removal in the thermocline
3. Application of a pressure-dependent correction to the bromide spectrum: better estimation of  $\text{NO}_3$  at depth

Regarding item (3) it was, indeed, observed that  $\text{NO}_3$  at 1000m could be underestimated up to 60% in the Eastern Mediterranean. An empirical correction of 2% per 1000 dbar on the seawater absorption coefficient was decided:

$$ESW(\lambda, Tis, P) = ESW(\lambda, Tis, P) \times [1 - 0.02 \times P/1000]$$

The SUNA sensor still undergo offset and temporal drift which can be corrected by comparing with climatological values at depth (<http://www.seasiderendezvous.eu>)

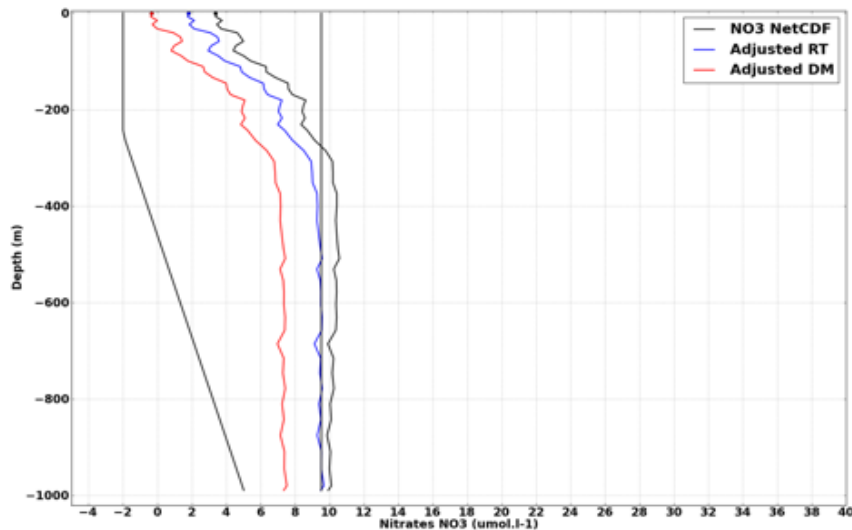

Figure 5.2.2 a.: Example of nitrate measurements from Argo float in the NW Mediterranean Sea (lovbio068d) at cycle 73 (15 March 2015). The black line represents the raw data transmitted in real-time (RT). The blue line, the nitrate adjusted in RT (offset correction) and finally the red line the nitrate adjusted in delayed mode (pressure, offset and drift correction).

D'Ortenzio F, Antoine D, Martinez R, d'Alcala MR (2012) Phenological changes of oceanic phytoplankton in the 1980s and 2000s as revealed by remotely sensed ocean-color observations. *Global Biogeochem Cy* 26 | doi: 10.1029/2011gb004269.

Pasqueron de Fommervault O, et al. (2015) Seasonal variability of nutrient concentrations in the Mediterranean Sea: Contribution of Bio-Argo floats. *J Geophys Res-Oceans* 120 | doi: 10.1002/2015JC011103.

Sakamoto, C. M. K. S. Johnson, and L. J. Coletti, (2009) An improved algorithm for the computation of nitrate concentrations in seawater using an in situ ultraviolet spectrophotometer. *Limnol. Oceanogr. Methods*, 7, 132–143.

### 5.2.3 Field data correction of pCO<sub>2</sub> optodes

pCO<sub>2</sub> optodes from Aanderaa have been used in a wide range of applications from shallow water lake, coastal and aquaculture measurements to deep water deployments on fixed or moving (gliders) platforms. The main advantages of these sensors include good long term stability once they have been deployed, compact size and low power consumption, 6000 m pressure rated and low pressure hysteresis. The main disadvantages are the difficulty to get them well calibrated, relatively slow response time and unknown stability over longer deployment period than 12 months. Before start using these sensors there are limitations that the end user need to be aware of including:

1. They cannot be used in environments where there is H<sub>2</sub>S which is normally found in anoxic (no O<sub>2</sub>) environments. H<sub>2</sub>S will irreversibly contaminate the sensor foils.
2. The sensor cannot be allowed to dry out. A cap with water in it will have to be placed on the sensor whenever it is in air.
3. The sensor has slow response (5 min) and has to be used with caution in profiling applications.

To obtain high accuracy data the end user will have to take high quality water samples for field adjustment sometime during the deployment. Preferably DIC and Alkalinity to calculate pCO<sub>2</sub>. It is recommended to always measure O<sub>2</sub> (with optode) in parallel, this give quality control and a better understanding of the ongoing processes. As can be seen from the calibration figure below (example from Atamanchuk et al., 2014) pCO<sub>2</sub> optodes, just like

other optodes, does not have a linear response with respect to solute concentration and temperature. For field correction, if a multipoint calibration has been performed, the whole calibration plane can however be moved up or down using just one reference point.

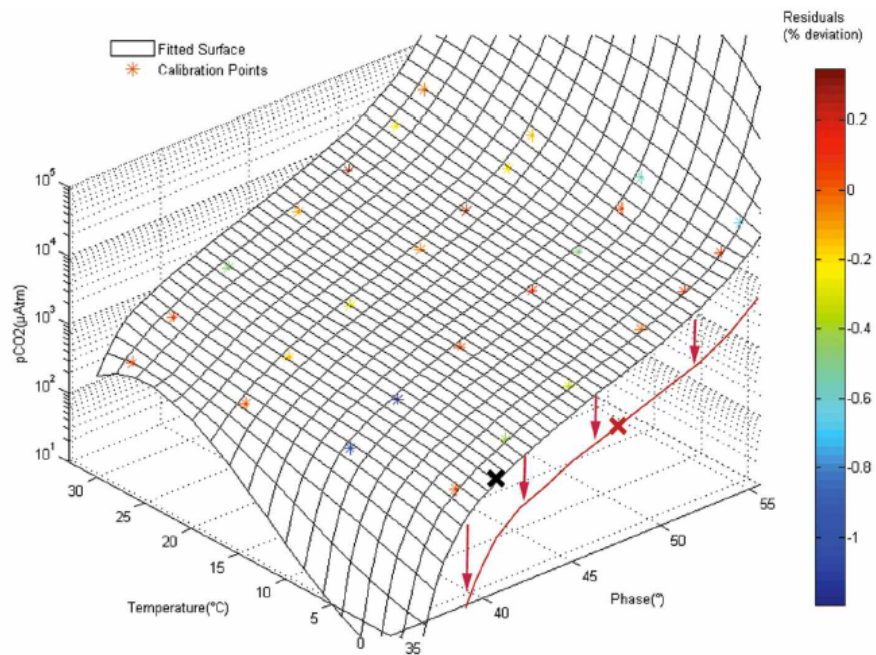

Figure 5.2.3a: Typical multipoint calibration curve for pCO<sub>2</sub> optode from Atamanchuk et al. (2014). For field adjustments the whole plane can be moved up or down using just one/some reference points.

One simple and approximate field method for single point referencing of a pCO<sub>2</sub> sensor before and after deployment is to place the sensors in constantly air-bubbled water, e.g. with aquarium pump, with approximately the same salinity as at the deployment site. This should be done in an environment that is open to the atmosphere. Doing this inside a laboratory should be avoided since there could be large changes in CO<sub>2</sub> depending on the number of people and activities in the room. As a reference for the concentration in the bubbled water the atmospheric concentration (normally around 400 µatm), which is specific for the region and season, can be used.

The recommended steps of sensor handling to obtain higher quality long-term field measurements are the following:

1. After calibration put the sensor in water that has similar salinity ( $\pm 5$  psu) as the water in which it will be deployed.
2. Keep the sensor wet at all times until it is submerged. For longer storage the black cap + sponge delivered with the sensor can be used. Tape around the lower edges of the cap to prevent water from escaping. To keep the sensor wet also just before deployment place toilet paper soaked in seawater of the right salinity on the foil. This paper will dissolve and be washed away when the sensor enters the water.
3. Let the sensor acclimatise (possible osmotic effects) for at least three days before taking reference water samples for adjustment. If possible, deploy O<sub>2</sub> optode and Salinity sensor close to the pCO<sub>2</sub> optode. The normal reverse correlation between O<sub>2</sub> and pCO<sub>2</sub> will give additional quality control and the possibilities to study on-going processes.

4. If possible, take reference water samples in the proximity of the sensors during at least two occasions during the deployment to be analysed for DIC and Alkalinity and calculate pCO<sub>2</sub> (with CO<sub>2</sub> sys).
5. Use CO<sub>2</sub> optode specific Excel sheet, provided with the sensor, that contains the equations to convert sensor raw data (Cal Phase) to pCO<sub>2</sub> values taking into account the sensors specific calibration coefficients. Please verify that the coefficients in the sensor and in sheet are the same. The coefficients are available by connecting the sensor to a PC (se manual).
6. Use adjustment coefficient in the Excel sheet to tune first set of reference data to sensor readings.
7. Verify with reference readings at other occasions that the sensor has been stable during the entire deployment.
8. If it is of interest to study and better understand the on-going processes in the studied area pCO<sub>2</sub> should be combined with another parameter in the carbonate system (preferably Alkalinity) to obtain DIC (calculated using CO<sub>2</sub> sys).
9. Changes in molar ratios between DIC and Oxygen can be compared and used to quantify and understand the on-going processes. For more information about how this can be done se Atamanchuk et al. (2015) Continuous long-term observations of the carbonate system dynamics in the water column of a temperate fjord. *Journal of Marine Systems* 148, 272–284.

The step-by-step procedure described above is targeted for pCO<sub>2</sub> optodes. Several of these steps should also be applicable to other pCO<sub>2</sub> technologies including: Take reference water samples at least two times during a deployment; Measure O<sub>2</sub> and Salinity in parallel with pCO<sub>2</sub>; Establish relation between Salinity and Alkalinity to be able to use measured Salinity as a proxy for Alkalinity. Then use Alkalinity + pCO<sub>2</sub> to calculate DIC; Use changes in molar ratios of DIC and Oxygen to quantify and understand the on-going processes.

#### 5.2.4 Data correction summary

The table below shows all correction methods usually applied in oceanography to adjust physical and biogeochemical data obtained from autonomous sensors. These methods can be used as Best Practices methods to correct bias observed in FixO3 data moorings.

Table 5.2.4 Summary of correction methods used nowadays for physical and biogeochemical parameters

Variables	Drift	Correction methods	Reference
Pressure	very low	Offset and bias ( $P_{bias}$ )	Karstensen, 2005
Temperature	very low	Offset (post-calibration)	Seabird manual, Karstensen, 2005
Conductivity	yes	Slope (bottles or post-calibration)	Seabird manual, Karstensen, 2005
Currents	low	Depth, local magnetic declination, sound speed	Karstensen, 2005
Dissolved Oxygen	Yes, low	Offset and gain	Argo oxygen manual, Takeshita et al. (2013)
Chl-a	yes	Offset with in situ data or satellite	

Variables	Drift	Correction methods	Reference
Nitrate	yes	Offset, pressure and drift	Johnson et al. (2013), Sakamoto et al. (2009)
pCO <sub>2</sub>	yes	Offset, pressure and drift	Atamanchuk et al. (2015)
pH	yes	no information yet	no information yet

Finally, pH and pCO<sub>2</sub> data from recent sensors (CONTROS, Aanderaa, Seafet, ...) are evoked but the quality control procedures are not ready to be proposed as best practices yet. So far taking water samples and analysing those for DIC and Alkalinity, using certified reference material, and calculating pH and pCO<sub>2</sub> appears to be the most robust. A calibration coefficients fitting seems to be the best way to correct the data for accuracy offset and drift.

## 6. Future directions (Univ. Aberdeen, 52North, UPC)

### 6.1 Sensor web enablement

Ocean observing systems use a wide variety of instruments and sensors types and there is little standardisation of the protocols used to control, configure and retrieve the data from these devices. To integrate these instruments into an observing system, a data management and instrument control framework is required. This is usually achieved using a proprietary framework, generally involving extensive manual configuration of specialised software drivers to translate commands and data between the protocols of the individual instruments. This highlights the need for the development of smart sensors to move towards the standardisation of instruments. A smart, or 'plug & play', sensor would (i) allow for easy integration into observing systems vis-à-vis connectors, power supplies, data formats, protocols and data handling, (ii) provide retrievable information about the sensor itself and (iii) be able to check for possible malfunction autonomously and report back to the operations centre.

Protocol standards such as the Open Geospatial Consortium (OGC) PUCK<sup>2</sup> have been developed in response to this need for standardisation between instruments. PUCK addresses the installation and configuration challenges for sensors by defining a standard instrument protocol to store and automatically retrieve metadata as well as other information from the instrument itself. The protocol is suitable for RS232 and Ethernet connected instruments. The PUCK commands do not replace existing instrument command sets, but are added to the existing commands. The PUCK standard has been implemented by several manufacturers, although it is not ubiquitous.

#### 6.1.1 Sensor web

Integrating observations gathered by different sensors in mapping software, Web applications, or computer models can be a cumbersome task requiring a lot of manual interaction. In addition, structured metadata such as provenance information, which is important for discovering sensor data within or between organizations or meaningfully using

<sup>2</sup><http://www.opengeospatial.org/standards/puck>



observations from heterogeneous sensors, is often missing in sensor data archives. Questions like “Which sensor has been producing the value with which quality?”, or “How has the sensor, which has generated this time series, been calibrated?” may not be answered, as the required metadata is missing. To address these issues, the Sensor Web Enablement (SWE) initiative of the Open Geospatial Consortium (OGC), launched in 2003, provides a suite of technical standards (Bröring et. al. 2011).

The core goal of the SWE initiative is enabling discovery, access, tasking, and analysis of sensors and observations via the internet. Therefore, the initiative has developed several standards (i) to model and encode information about sensors and observations and (ii) to provide sensor-related functionality via web services in the internet. These are illustrated in the following paragraphs.

### 6.1.2 SWE information models

In order to ease the exchange of sensor data in the Web, standardized information models and encodings are needed. Existing models and formats are either missing explicit fields for spatial information, e.g. Excel or CSV sheets, are only suited for vector data, e.g. ESRI's shape file format, or better suited for gridded data, e.g. NetCDF. Nearly all of them are missing pre-defined fields for sensor parameters and information about what has been observed. Hence, the OGC SWE initiative has defined the *Sensor Model Language (SensorML)* and *Observation & Measurements (O&M specifications)*. O&M provides a standard data model as an ISO standard and a corresponding XML-encoding as an OGC standard<sup>3</sup>. According to O&M, an observation consists of:

- Spatial location (optional)
- Timestamps (sampling time and time when result has been generated, if these differ)
- Observed phenomenon
- Sensor that has produced the value
- Result values (sensor output)
- Optional additional metadata, e.g. quality information

Several specializations of the basic O&M observation are available, e.g. Temporal- or Spatial Observation or Time Series Observation. Furthermore, it is encouraged to define domain-specific profiles of O&M by restricting the optional elements and adding domain-specific parameters. An example for such a profile is the Water Markup Language (WaterML) 2.0 from the domain of hydrology<sup>4</sup>.

For providing a common model and format to describe sensors, SensorML has been specified by the OGC<sup>5</sup>. It allows to provide sensor metadata, such as:

- Type of sensor
- Spatial location
- Inputs and outputs
- Operator
- Additional parameters like calibration information

<sup>3</sup><http://www.opengeospatial.org/standards/om>

<sup>4</sup><http://www.opengeospatial.org/standards/waterml>

<sup>5</sup><http://www.opengeospatial.org/standards/sensorml>

As a common practice, SensorML documents are usually referenced from the observation data encoded in O&M. As XML may enlarge the size of data that needs to be transferred, more lightweight encodings have been defined, e.g. a JSON encoding. However, these are not yet officially standardized by the OGC, but supported by some SWE tools.

### 6.1.3 SWE web services

An overview on the different SWE service standards using an example from the hydrology domain is given in Figure 6 a. For querying observation data with explicit space-time information, the OGC has defined the *Sensor Observation Service (SOS)*<sup>6</sup>. It defines a Web service interfaces for sub-setting observational data by pre-defined filter parameters, e.g. spatial and/or temporal extent or particular sensors, and to retrieve these subsets in standardized formats, usually the XML-based O&M format. Besides querying the actual observational data, clients are also able to retrieve detailed metadata about the sensors that have generated the observation data. The SOS can be used with sensor networks for real-time data delivery, but can also be deployed as a standardized web interface for already existing sensor data archives consisting of files or implemented using common DBMS. Per default, O&M is the format for observational information and SensorML is for the sensor descriptions. However, the SOS specification does not restrict the response formats. Hence, a SOS can also serve other common data formats, such as NetCDF for gridded observations or CSV for time series data.

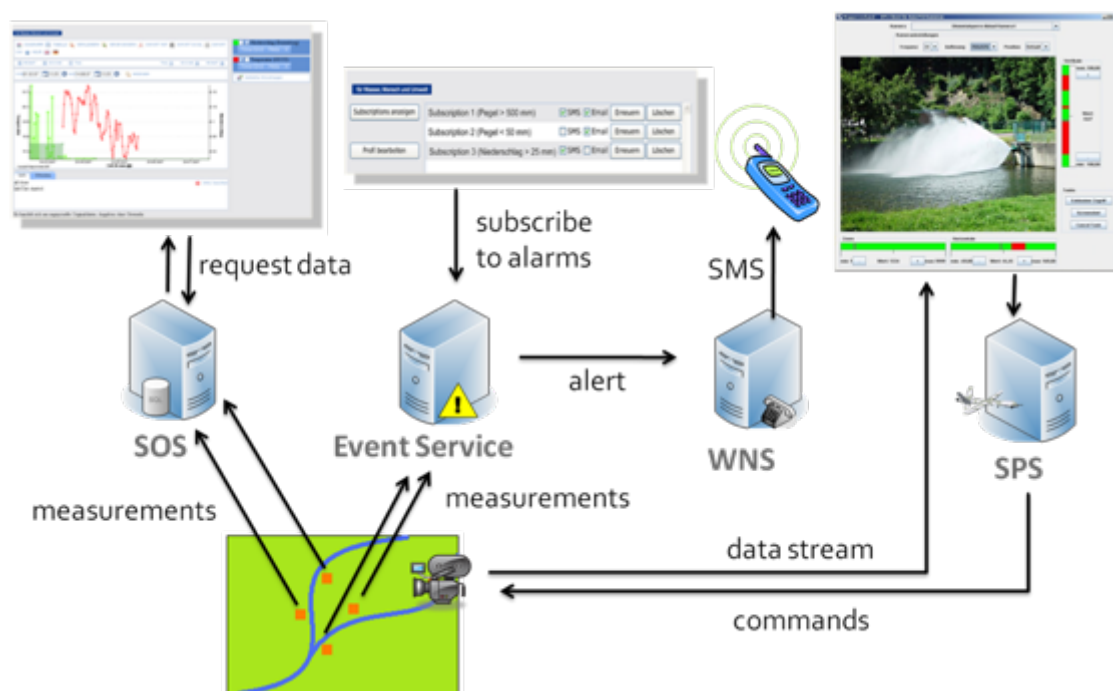

Figure 6.1.3 a: Overview on SWE Web Services

<sup>6</sup><http://www.opengeospatial.org/standards/sos>

While the SOS provides an interface for actively querying observational information, there is also a need for being able to subscribe to certain sensor events, e.g. if a certain threshold value is exceeded by a sensor output. For this purpose, the *Sensor Event Service (SES)* and the *Web Notification Service (WNS)* have been defined<sup>7</sup>. The SES allows to subscribe to certain sensor events and the WNS can be utilized to notify subscribed users in case of certain events. As an example, SES and WNS allow users to register to an event “sea surface level above 5 meters” and to be notified via SMS, if this value is exceeding at a certain sensor station. This is in particular useful for sensor maintainers, e.g. if unusual values are reported, or in disaster management applications to detect severe weather events. While the SOS and the Sensor Planning Service (SPS) are official implementation standards, the SES and the WNS are published as discussion papers. As such, they are not official standards yet. They may be replaced in future by a general publish-subscribe interface that is currently under development by the OGC Pub/Sub Standards Working Group.

The *Sensor Planning Service (SPS)* can be used to task sensors via the internet<sup>8</sup>. The web service offers operations for registering new sensors, for retrieving information about registered sensors and tasking capabilities and for executing task. As examples, the SPS can be used to change the sampling rate of a sensor station or to re-locate sensors, if these are mounted on mobile platforms.

#### 6.1.4 SWE applications

Sensor Web technologies are already in use in a variety of different domains and use cases. Examples are the usage of SOS servers by the European Environmental Agency to collect air quality measurements from the European member states or the U.S. Integrated Ocean Observing System (IOOS) where oceanographic measurements are served via the SOS interface.

Several implementations of SWE standards are available. The most widely used open source SOS implementation, the 52N SOS, is maintained by the 52°North open source initiative<sup>9</sup>. Furthermore, 52°North implements the full suite of SWE services including SPS, SES and WNS and provides several client implementations to use them, e.g. in Web browsers. Further implementations of SOS servers are also available, e.g. the istSOS implemented in Python<sup>10</sup> or a C-based extension of the UMN map server<sup>11</sup>. Commercial SOS implementations are available as well, e.g. by Northrop Grumman.

#### 6.1.5 Perspectives for ocean observatories

A common way and best practice to apply Sensor Web technologies in the oceans domain are not yet available and are currently being investigated, e.g. by the FP7 NeXOS project<sup>12</sup>. Therein, a Sensor Web architecture has been defined and is currently being developed as prototypical implementation. Further European research projects will also explore the usage of SWE in the Ocean domain, e.g. ODIP, ODIP 2, COMMON SENSE, or BRDIGES.

<sup>7</sup> The WNS and SES discussion papers are accessible at <http://www.opengeospatial.org/standards/dp>

<sup>8</sup> <http://www.opengeospatial.org/standards/sps>

<sup>9</sup> <http://www.52north.org>

<sup>10</sup> [https://geoservice.ist.supsi.ch/projects/istsos/index.php/Welcome\\_to\\_istSOS\\_project](https://geoservice.ist.supsi.ch/projects/istsos/index.php/Welcome_to_istSOS_project)

<sup>11</sup> [http://mapserver.org/de/ogc/sos\\_server.html](http://mapserver.org/de/ogc/sos_server.html)

<sup>12</sup> <http://www.nexosproject.eu/>

In particular, the Sensor Web may help to provide sensor-related metadata in a structured and standardized way. This will address two issues, i.e. sensor *discovery* and observation *provenance*. While more and more observation data is made available within or between organizations, it is still difficult to find appropriate sensors and data sets for a certain application. SWE metadata would allow to search for spatial and/or temporal extents, sensor types, or sensors with a particular quality level. SWE metadata also allows to trace observations back to the sensors that gathered these observations. By means of SensorML, it is also possible to describe further processing steps, e.g. aggregation or interpolation, allowing to provide *provenance* information from the sensor up to a final information product.

Once the usage of SWE technologies is established, it will also ease the *exchange* of observation data between communities and would allow to integrate external Sensor Web data sources without much effort. Furthermore, as these formats are relying on common web formats, it is easy to build web clients utilizing the data or *linking* the data to other web resources, e.g. dictionaries describing the parameters that are observed. This would allow to add additional information or clarifying the semantics of the data.

In general, connecting the sensors to the Web and making their data and functionalities available also enables an easier maintenance and operation of sensors from remote. For example, using the notification mechanisms from WNS and SES, sensor operators may be notified in case of unusual observed values. By using the SPS, they can then re-configure the sensor, e.g. changing the sampling rate.

To sum up, Sensor Web technologies may close the information gap between sensor data producers and sensor data consumers. The Sensor Web also provides means to remotely operate sensors via the internet and to provide additional metadata such as provenance or quality information. At the moment, best practices and common architectures to utilize Sensor Web technologies in the Oceans domain are being investigated and implementations of those are developed. Thus, SWE may ease the work of sensor operators, domain scientists and modellers.

## 6.2 Other fields of improvement

- The EMSO concept of EMSO Generic Instrumentation Package will be implemented by the EC Horizon 2020 EMSODEV project, starting in September 2015. We can expect improvement in standardization on the way to group the sensors on essential ocean variables and seabed parameters, improve Qc and calibration processes. This development will continue the FixO3 Front end adaptation performed in WP12. One can envisage similar electronics on buoys, standalone seabed observatories and as final interface of cabled observatories.
- Light materials such as new cable fibers, improved syntactic foams, composite materials are under validation for marine use. This may bring more efficient mechanical designs for the various FixO3 platforms. As mentioned above, the time life of stretch hoses is a limitation to some improvements in mooring line design.
- Innovative solutions are under test to avoid to leave ballast on the seabed at each mooring deployment: use of suction anchors, patented pressurized gas ballasting system by Ifremer.
- Acoustic observation by sounders and new types of cameras are deployed on observatories. This may lead to an additional field for sharing best practices.

## Appendix A. Glossary

### **Accuracy**

Degree of closeness between the result of a measurement and the value of the measure (or true value of the measurement).

### **Acoustic releaser**

Device installed on moorings or sea-bed platforms that allows their recovery by means of acoustic command.

### **Acquire**

Obtain the rights to use an entity or resource. Note that the entity itself is not acquired, only the rights to use it.

### **Activity**

A task or grouping of tasks that provides a specialized capability, service, or product.

### **Adaptive Sampling**

Adaptive sampling is a sampling design in which sampling regions are selected based on values of the variables of interest observed. Within FixO3, adaptive sampling can be used to modify sampling times of fixed platforms, sampling times and depths of profilers and sampling times, depths, and positions of mobile platforms. Adaptive sampling may be user directed based on real time data or autonomous based on programmed mission files.

### **Anchor**

Device used to moor oceanographic platforms to prevent their drifting.

### **Architecture**

A concept that identifies components and their associated functionality, describes connectivity of components, and describes the mapping of functionality onto components.

Architectures can be of different types, e.g., hardware, software, or system, and can be domain-specific.

### **Architecture Document**

A representation that identifies components and their associated functionality, describes connectivity of components, and describes the mapping of functionality onto components. Architectures can be of different types, e.g., hardware, software, or system, and can be domain-specific.

### **Argos beacon**

Device used to retrieve mooring lines in case of cable break. When the beacon reaches the surface, it transmits an alert through ARGOS satellite system that enables its identification by means of its position.

### **Array**

A collection of sites, nodes and platforms with a common scientific focus

### **Ancillary functions**

Functions of an element devoted to keep its operation capacity over time including its health, its protections against fouling and corrosion, the sensing of internal parameters.

### **Authentication**

The act of establishing or confirming an entity as a trusted member of a community. This might involve confirming the identity of a person, the origins of an artefact, or assuring that a computer program is what it is reported to be.

### **Availability**

The ratio of (a) the total time a functional unit of software or hardware is capable of being used during a given interval to (b) the length of the interval.

## **Backhaul**

The link (fibre-optic) between the shore station and “centre”

## **Basic Core Seafloor Measurements (BCSM)**

Co-located measurement of pressure, single point near bottom currents, acoustic pressure waves, ground motions associated with variable magnitude earthquakes (<1 to > 7), and water temperature in sites located at all plate boundaries and intraplate. Competes with generic sensors.

## **Beach Manhole**

A vault at a beach to allow buried cable to come to the surface at the shore station.

## **Benthic experiment package**

A mounting platform for sensors that require proximity to the seafloor. Complementary to generic sensors.

## **Buoy**

A device whose weight is less than that of an equal volume of the sea water in which it is deployed. The excess buoyancy provided by the buoy can be used to counter the weight of a mooring and drag forces caused by current, wind, or wave actions. A buoy may be either a surface or subsurface buoy.

(1) Surface buoys have some of their volume above mean sea level and can be used to support components, such as meteorological instruments or radio telemetry subsystems that must be operated above the water level.

(2) Subsurface buoys remain completely submerged except during deployment and recovery of a mooring.

## **Burst sampling**

Intermittent rapid sampling that far exceeds the standard time series measurements requirements. The rate of burst sampling and the duration will generally be instrument specific but will require the ability to measure and record data at rates that can exceed 1 Hz.

**Cable**

A bundle of electrical and/or optical conductors, insulated from each other and protected as a whole with an external jacket, used for transmission of power and data. Cables may include a strength member and external armouring. Cable can refer to bundles with or without connectors or terminations. Cables may connect seafloor components, or may be components of moorings.

**Cable Assembly**

Cable segments with connectors or terminators.

**Cabled observatory**

Seabed platforms connected to land by underwater cables.

**Cable Line**

The entire string of Cable Segments extending from a Cable Shore Station to the last Primary Node on the string.

**Cable Segment**

The cable and equipment between a Cable Shore Station and a Primary Node or the cable and equipment between two Primary Nodes.

**Cable Shore Station**

The shore terminus of a Cable Line and contains all equipment required to operate that particular Cable Line. Synonymous with Shore Station.

**Calibrate**

Test and/or adjust the accuracy of a measuring instrument or process by comparing its output with a reference.



**Catalogue**

Entity that keeps track of resources and enables their discovery or query.

**Co-located**

Different measurements located in proximity adequate enough to accomplish the specified effort.

**Communications and power manager**

A microcomputer that monitors and controls the use of telemetry devices and forwards power restrictions to DCL's based on the availability of platform power.

**Compliant mooring**

A taut mooring that incorporates compliant hose to allow a surface buoy to move freely with the waves without accelerating subsurface mooring components and deeper instrumentation.

**Configuration**

The set of parameters that defines how a computer or system operates.

**Configuration Control**

An element of configuration management consisting of the evaluation, coordination, approval or disapproval, and implementation of changes to configuration items after formal establishment of their configuration baseline.

**Configuration Management**

The technical and administrative direction and actions taken to identify and document the functional and physical characteristics of a configuration item; to control changes to a configuration item and its characteristics; and to record and report change processing and implementation status.

## **Configure**

Set up an entity for use, testing, or operation. An entity can be configured for normal or specific operating modes; this may happen at any point in the life cycle of the entity, as long as it does not violate FixO3 recommendations.

## **Controller**

A device or system that may manage power and/or communication for multiple sensors or multiple actuators.

## **Co-registered**

Different measurements made within 1 meter of each other. For black smoker systems, co registered measurements of temperature and chemistry are made in the same orifice, space allowing.

## **Creep**

Slow movement along a fault that may be seismic or aseismic; slumping of landforms (rock or sediment) such as may occur in zones of gas hydrate formation.

## **Cyberinfrastructure**

The term "cyberinfrastructure" describes research environments that support advanced data acquisition, data storage, data management, data integration, data mining, data visualization and other computing and information processing services distributed over the Internet beyond the scope of a single institution.

## **Data**

Term that is not used in its unqualified form. In the oceanography domain, refers to the measurements that come from sensors and not to any data products computed based on these measurements. Observational data is synonymous.

## **Data Acquisition System**

An assembly of controllers, sensors, actuators.

### **Data Circuit-terminating Equipment**

Equipment that handles the signal conversion and coding necessary for coupling the Data Terminal Equipment (DTE) to a communications link.

### **Data Concentrator/Logger**

A microcomputer based entity that is the hardware interface to moored CGSN sensors, responsible for configuring, powering and monitoring health of sensors, acquiring and storing data and forwarding data as requested either directly to a telemetry device or via the Communications and Power Manager (CPM).

### **Data Logger**

Data Sampler with persistence. Can have a concept of time.

### **Data Management**

The principles, processes, and systems for sharing and controlling information resources.

### **Data Product**

An information product that is derived from observational data through any kind of computation or processing. This includes aggregation, analysis, modelling, or visualization processes.

### **Data Source**

An entity that produces data, possibly including all antecedent data. products and data sources.

### **Data Stream**

A sequence of data packets used to continuously transmit or receive information, typically in real time and without any direct action on the part of the data consumer.

## **Data Terminal Equipment**

The functional unit that serves as a data source or sink. It is typically connected to Data Circuit-Terminating Equipment (DCE) in order to send or receive data over a communications link.

## **Database**

A collection of data arranged for ease and speed of search and retrieval.

## **Dataset**

Any information product handled by the CI Data Management services network. A dataset contains the actual information product as well as descriptive metadata on potentially multiple levels. Examples of data sets include observational data, derived data, data products, aggregate data, or analysis and visualization data products.

## **Deactivate**

Disable to preclude further use; stop using.

## **Decommission**

To permanently take out of service.

## **Deep profiler**

A profiler used to profile the water column from as close as practicable to the seafloor to 150-200 m below the sea-surface.

## **Deploy**

Put an entity into a given location, context, or configuration (typically, the final location where it is intended to operate-this is part of the FixO3 plans.

## **Deployment**

Interval The period between launch and recovery.

**Detect**

Derive from a stream of information or data the knowledge that a condition has been met. Detection may be followed by other automated actions, including notification of interested parties, presentation of relevant information, and controlling the response.

**Determination**

To ascertain a quantity or trend by application of observation(s) or investigation.

**Device**

An electronic or optronic apparatus that can be connected through peer-to-peer communication and can provide information and data about itself and/or its environment. Device can encompass both sensor and actuator.

**Documentation**

The list of artefacts used to describe the entities identified and the operations performed on them. Documentation can be embedded or external, static or dynamic, automatically generated or manually composed. It can be more or less structured, and can encompass comments and other auxiliary information.

**Domain Model**

A conceptual model of a system that describes the involved entities and their relationships.

**EIA RS-232-C**

Serial Link Standard for serial binary data signals connecting between a DTE

**Electrical Mechanical (EM)**

Designating mooring elements with copper conductors to allow power and data to flow through the mooring line. EM elements include molded chain and stretch-hose with spiral wrapped conductors.

## **Electrical Optical Mechanical (EOM)**

Applied to transmission system such as a cable. It transmits power through electrical wires, data through fiber optics and has a mechanical function such as mooring.

## **Element Management System**

System to manage power, communication, ancillary functions and equipment health for specific nodes or subsystem components.

## **Enable**

(1) Make possible; does not directly perform; provide basic measurements, data, or components to a system or process; a catalyst;

(2) For the FixO3 network, defined as providing the measurement, data, and/or services to allow the end-user to conduct scientific research into one of more FixO3 high priority science topics.

## **Encryption**

The translation of data into a secret code, unreadable without special knowledge.

## **Environmental Consumable**

Natural resources or properties such as sound, light, terrain, chemicals, etc. represent those consumables that the observatory sensors will attempt to use. Those consumables may or may not be renewable.

## **Erbium Doped Fiber Amplifier**

Sometimes called an optical amplifier, an EDFA is a section of optical fiber that is doped with rare earth elements and pumped with a diode laser that boosts the intensity of an optical signal. This allows optical transmissions to be amplified without any electronic conversions.

## **Ethernet**

A family of frame-based computer networking technologies for local area networks (LANs) standardized as IEEE 802.3.

### **Eulerian observatory**

Unmanned platforms, which incorporate sensors for making in situ measurements of the properties of the surrounding water or sediment or the processes occurring there. They may also collect samples of water, fauna or solids and, in general, incorporate a variety of sensors from different disciplines.

### **Fixed point observatory.**

Moored observing stations

### **Exchange Point**

A topic of conversation within an exchange. Producers and consumers of information messages interact in a publish-subscribe way through an exchange point. Each exchange point is represented as message queue on a message broker.

### **Exchange Space**

A collection of exchange points within an exchange, often driven by topic or organizational structure.

### **Expandable**

Capable of increasing in scope, number of components, or reach (physical extent).

### **Experiment**

The combination of one or more users, tools, and instruments used in concert to (in)validate a scientific hypothesis. An experiment will produce data products and metadata describing it. An experiment can be interactive (requiring the presence of a user to drive it and make decisions to alter its course) or autonomous (pre-programmed).

### **Extensible**

Capable of expanding in scope, effect or meaning (logical concept) Ex: adding features.

**Extensible Markup Language (XML)**

A cross-platform, extensible, and text-based standard for representing data. It is a key technology in the development of web services.

**Extension Cable**

Includes Connectors - Cable - CTA. Synonymous with Extension Cable Assembly

**External Aggression**

Potentially damaging force(s) which may result from human activities (e.g. trawling, drilling, anchoring), but which are not caused by normal system operation.

**External Stakeholder**

An interested party that is not normally a member of the observing system or cyberinfrastructure; often refers to governmental or organizational entities that will benefit from or be affected by outputs of the system.

**Federation**

The process of transparently integrating multiple, autonomous, distributed elements of the cyberinfrastructure.

**Firewall**

A network security system used to monitor and restrict traffic between two networks.

**Float**

Device that is buoyant in water.

**Flux**

The rate at which momentum, energy, or mass passes over a distance or through an interface (e.g., air-sea, mixed layer-deep ocean, sediment-water).



**Format**

The structure of something, e.g., a data product or data stream.

**Frame**

Submersible metallic structure that hosts scientific equipment.

**Front end electronics**

Interface to several sensors, actuators and instruments. It may be installed in or as an extension of a Junction Box or be the central element of a standalone platform.

**Galvanic**

Isolation Isolating functional sections of an electric system so that there is no electrical path for current to directly flow from one section to the next.

**Glider**

An autonomous underwater vehicle that propels itself through changes in buoyancy.

**Hull**

Main body of an oceanographic buoy.

**IEEE 802.3 10/100Base-T**

Standard 10 Mbits/sec and 100 Mbits/sec Ethernet over 2 pair of copper conductors.

**IEEE 802.3ab 1 GigE**

Standard for gigabit (1000 Mbits/sec, 125 MBytes/s) Ethernet over wiring that requires four pairs of copper wires.

## **Infrastructure**

a) Technical structure that supports observations. In regard to ocean observatories infrastructure encompasses the platforms, supporting structures, cables, power supply, communication components and also the software components that are needed for operating the observing system. In some cases instruments and sensors are seen as part of the infrastructure in others not.

b) A set of research equipments allowing to host several types of experiments. Infrastructure-Instrument Port (ii-port)

Physical interface between instrument link and infrastructure. SIIM would be an example or instance of an ii-port that includes communications, time management, and power management capabilities.

## **Instrument**

A device that contains one or more sensors and a method for converting the information from the sensor into a transmittable and storable form.

## **Instrument Life Cycle**

The suite of events that define the life of an instrument from the expression of its mandate (via the requirements); its purchase or fabrication; its test, integration and deployment; its operational life, including maintenance activities; through to its decommissioning and removal.

## **Instrument Link**

Cable or other (acoustic) connection between instrument and infrastructure.

## **Interactive Visualization**

A visualization that allows human control of some aspect of the visual representation of information, and in which changes made by the human are incorporated into the visualization in a timely manner. In general, interactive visualization is considered a soft real-time task.

## **Interface Requirements (IR)**

Requirements which describe interactions across a boundary, e.g., between IOs, between an IO and an external entity, or between ESONET-EMSO and an external entity.

## **JBox (Junction Box)**

Physical instance of a node, incorporates one or more Instrument Interface (II) ports (to be discussed).

## **Key Performance Parameter**

Key Performance Parameters (KPPs) are the performance characteristics that must be achieved by the design solution. They are the minimum set of measurable and testable attributes or characteristics considered most essential for the system's capability. They flow from the operational requirements and the resulting derived measures of effectiveness (MOEs). They can be identified by the user, the decision authority, or the operational tester.

## **Lights Out Management**

In computing, involves the use of a dedicated management channel for device maintenance. It allows a system administrator to monitor and manage servers and other network equipment by remote control regardless of whether the machine is powered on.

## **Low Power Junction Box (LPJBox)**

A node providing regulated DC power and 100BaseT or serial interfaces to Instruments through and Instrument Interface (II) ports.

## **Low Voltage Node (LVNode)**

A node distributing 375 VDC power and 1 GigE datalinks to other LVNodes or MPJBoxes and 48 VDC power and 100/100 Mbps datalinks to LPJBoxes.

## **Maintain**

Keep an entity in an operational state; includes the following sub-activities: configure, calibrate, monitor, clean and refurbish.

## **Maintainability**

Probability that a specified software or hardware item will be retained in, or restored to, a given condition in a given period of time, when maintenance is performed in accordance with prescribed procedures and resource.

**Manage**

Administer, maintain, and regulate, as in resources under one's control.

**Marine Node**

A node in the marine environment.

**Marine Repair**

Repair required seaward of the beach manhole.

**Materials Resource Planning**

Materials Resource Planning (MRP) is a system for effectively managing material requirements, inventory, and costs in a manufacturing process.

**Measurement**

The sampling and determination of mass, volume, quantity, composition or other property of an object or event.

**Medium Power Junction Box (MPJBox)**

A node providing regulated DC power and 100BaseT or serial interfaces to Instruments through Instrument Interface (II) ports. Medium Power Junction Boxes have expansion capabilities to connect other MPJBoxes.

**Medium Voltage Converter**

A DC/DC converter that takes a voltage of order 10 kV at its input and delivers a reduced voltage of a few hundred volts as output.

**Message**

A unit of communication between agents.

## **Message Broker**

Software system installation that enables asynchronous message passing communication between distributed processes. Provides queues as end-points for message providers and consumers and performs routing of messages from producers to consumers, potentially across several queues.

## **Metadata**

The set of attributes and their values that characterize a particular resource.

## **Midwater platform**

A component of the cabled hybrid profiler mooring. The midwater platform is a subsurface float located 150-200 m beneath the ocean surface. The RSN midwater platform is connected by conducting cable to the low voltage junction box. The midwater platform will provide a resting position for the winched profiler. It will also serve as the upper float supporting the deep profiler. The platform will also support fixed sensors.

## **Mission**

An operational task, defined by a mission plan, during which the vehicle is active and sampling. A mission may be bounded by launch and recovery, docking events for AUVs, or quiescent mode for gliders.

## **Mission file**

Command files used by AUV's/gliders to allow new waypoints to be specified along with revised sensor sampling strategies, revised speed, etc.

## **Modem, acoustic**

An electronic device which transmits data bi-directionally between two subsystems using modulated sound waves.

## **Modem, inductive**

An electronic device which transmits data bi-directionally between two subsystems using an inductive loop. In oceanography the loop typically consists of a plastic-jacketed wire rope (to which sensors employing inductive modems are mounted) closed by a return path through sea water.

**Module**

Functional component in a distributed system. The unit of granularity in an operational distributed system architecture. Modules can be hierarchically decomposed if necessary.

**Molded chain**

Mooring chain with spiral-wrapped conductors (and optionally) optical fibres encased in urethane.

**Monitor**

Observe and check the progress or quality of something over a period of time.

**Mooring**

Physical platform, containing a buoyant element constrained to a geographic location by an anchoring device.

**Mooring, Flanking**

An oceanographic mooring located at a horizontal distance from a main mooring to allow the resolution of mesoscale structure, typically at a distance of 50 to 100 kilometres.

**Mooring, Hybrid Profiling**

A mooring that enables measurements over nearly the entire water column using two, potentially different, types of profilers. One profiler covers the range between a midwater float and the surface and another covers the range between the midwater float towards the bottom.

**Mooring, Sub-surface**

Buoyant element is below the surface, no surface expression.

**Mooring, Surface**

Permanent surface expression, Buoyant element is at the surface.

### **Multi-function Node (to be renamed)**

A base component used by CGSN moorings. The MFN serves as the mooring anchor, terminates the bottom of the mooring and provides data and power ports for benthic

instrumentation.

### **Network**

(1) A physical or virtual link allowing the instantiation of peer-to-peer communication between computing entities in the system;

(2) A system of interconnected components. Network Management System Supplier furnished

### **Node**

(1) Entity that aggregates ports and/or distributes power, time, communications; can be chained. Examples: buoy controller, DCL, glider, profiler, J-Box.;

(2) An abstract unit used to build linked architectural structures. Each node contains activities and possibly links to other nodes.

### **Observatory**

An infrastructure that is able to accommodate sensors and instruments either permanently installed or by demand. Observatories are able to provide certain services like power supply and communication links for all connected instruments. Example: Global, Regional,

### **Observatory Management System**

A software application with interfaces to all of the Primary and Secondary Infrastructure Element Management Systems (EMS) to provide a single point of interface for command and control of the regional infrastructure for the Cyber Infrastructure and for the Regional Operations Centre.

### **Ocean Bottom Seismometer (OBS)**

Seismometer designed to monitor acoustic and seismic natural or anthropogenic events.

## **Ocean Ground Bed**

The Primary Infrastructure “ground anode” located at the Cable Shore Station or on the ocean floor near the ocean terminus of the bore pipe. The return current from all Primary Nodes terminated at the Cable Shore Station will be returned to “earth” at this location.

## **Operate**

(1) Correctly performing designed functionality; (2) To cause to function.

## **Operational Period**

The period of time less than or equal to the deployment interval during which the vehicle is actively operating (i.e. executing missions). The operational period may not be continuous (e.g., for AUVs this does not include times the vehicle is docked).

## **Operational Unit**

Instantiation of a deployable unit in an execution environment after all initialization and contextualization activities are finished and the unit exposes its services.

## **Operations Centre**

An area containing computer consoles with network connections to the CI control/management system and the Observatory Management System used to monitor, troubleshoot and maintain the whole of the infrastructure.

## **Peer-To-Peer Communication**

The direct exchange of information between two entities using a communication network following a well-defined protocol that can include authentication and authorization.

## **Performance Parameter**

A measure of behavior or effectiveness of a system; can be used to guide and control progressive development.



**Persist**

The process of storing information resources throughout the ESONET observatory life cycle.

**Physical location**

Measurements at the same physical location not only have to be geographically close but also within close proximity on a platform, i.e., they may be as close as a few centimetres (as determined by the specific instruments).

**Platform**

Collection of nodes, sensors, instruments together with necessary controllers physically connected together, with a known external geometry. Example: Mooring, Surface Mooring, Profiler, AUV, Glider.

**Platform controller**

The electronic hardware (deep and shallow moorings, gliders and AUV's) that is responsible for autonomously or interactively conducting the operation of these platforms.

**Plume**

A buoyantly-rising volume of water that has anomalous chemical and physical properties with respect to background ocean water.

**Point of Presence (POP)**

Aggregation point for resources on a network; Example: CyberPOP.

**Port**

An individually identified physical connection point for a sensor, instrument, node.

**Power Feed Equipment**

The electronic subsystem, normally located in a shore station, that converts mains power to high voltage DC to supply a submarine cable system.

## **Precision**

The closeness of agreement between independent measurements obtained under stipulated conditions of repeatability, generally expressed as a standard deviation (or standard uncertainty) of measurement results (Taylor and Kuyatt, 1994). Used as a measure of the stability of an instrument/sensor and its capability of producing the same measurement over and over again for the same input signal.

## **Primary Node**

An underwater unit that receives high-voltage DC power and multi Gbps communication links from a Cable Shore Station and provides regulated low voltage power and Gbps communication to a set of “Secondary Infrastructure” science instruments.

## **Privilege**

The necessary authorization requirements that give a user a right to perform a particular role. Designated sequence of operations or events, possibly taking up time, computation power, or other resources, that produces some outcome; may be identified by the changes it creates in the properties of one or more objects under its influence.

## **Process Definition**

Source or executable format of a user-provided process to analyse, transform or otherwise manipulate resources, such as data and data products, and to produce output in various forms to the data distribution network, such as derived data products, detected events, etc. A process definition can be scheduled and instantiated into a process.

## **Processing Level**

A rating given to a data product indicating the level of sophistication of the data set. DATA PRODUCT LEVEL. Data levels 1 through 4 as designated in the Product Type and Processing Level Definitions document. Source: SPSO.

## **Raw Data**

Data in their original packets, as received from the observer, unprocessed by EDOS.

Level 0. Raw instrument data at original resolution, time ordered, with duplicate packets removed.

Level 1A. Reconstructed unprocessed instrument data at full resolution, time referenced, and annotated with ancillary information, including radiometric and geometric calibration

coefficients and geo referencing parameters (i.e., platform ephemeris) computed and appended, but not applied to Level 0 data.

Level 1B. Radiometrically corrected and geolocated Level 1A data that have been processed to sensor units.

Level 2. Derived geophysical parameters at the same resolution and location as the Level 1 data.

Level 3. Geophysical parameters that have been spatially and/or temporally re-sampled (i.e., derived from Level 1 or Level 2 data).

Level 4. Model output and/or results of lower level data that are not directly derived by the instruments.

### **Profile**

One vertical transit by the profiler between its end points (i.e., a round trip is two profiles)

### **Profiler**

A platform (profiler body) containing a suite of instruments and sensors that are raised and lowered through the water column on a regular basis.

### **Protocol**

A well-defined exchange of tokens (words, packets, etc.) allowing two or more peers to communicate.

### **Publish**

Make something generally known; present something in a format for others to assimilate.

### **Publish/Subscribe**

An asynchronous messaging paradigm where senders (publishers) of messages are not programmed to send their messages to specific receivers (subscribers). Instead, published messages are characterized into classes without knowledge of what (if any) subscribers there may be. Subscribers express interest in one or more classes, and only receive messages that are of interest, without knowledge of what (if any) publishers there are. This decoupling of publishers and subscribers provides greater scalability and a more dynamic network topology.

## **Quality Assurance**

A planned and systematic means for assuring management that defined standards, practices, procedures, and methods of the process have been followed in the performance of a job.

## **Quality Control.**

The operational steps performed to enforce quality of a particular product.

## **Quantification**

The analysis of measurements to describe a change in properties expressed as a numeric value.

## **Queue**

Separates producers and consumers of messages in a message passing system; provides a virtual channel with quality of service guarantees. Sink for messages provided by producers and sources of messages forwarded to consumers. Guarantees message ordering, and exactly once message delivery semantics in a transactional context.

## **Range**

The distance a vehicle can travel relative to the water without recharging. Range is dependent on mission parameters and environmental conditions.

## **Raw Data**

The unmodified set of information provided to the CI by an instrument or the marine infrastructure. Synonymous with observed data. Raw data might have already undergone transformation, filtering and correction by the instrument provider. Any such modifications are outside of the control of the CI. The CI will make sure that any raw data it receives from instruments and marine infrastructure will be persisted in their unmodified form.

## **React/respond**

Perform a pre-planned action once an event has been detected. The response can be a simple warning message sent to the owner of the event detection or a more elaborate process that involves the intervention or mobilization of various actors who will further observe and confirm the detected phenomenon.

**Real Property**

Land, including land improvements, structures and appurtenances thereto, but excluding movable machinery and equipment.

**Recipient**

The receiver of information.

**Recover**

To disconnect and retrieve a deployed component from the system.

**Refurbish**

Bring a device to its nominal state and confirm it is ready for re-deployment in operations.

**Register**

Provide information about an entity or resource to a service that is responsible for logging and publishing it.

**Registrar**

Operational entity responsible for ingesting and organizing information about resources.

**Registry**

An official list, catalogue, or source of information about resources.

**Release**

(1) As a verb, it indicates that an entity no longer wishes to use another entity or a resource (the inverse of acquire); (2) As a noun, it refers to the distribution of an initial or upgraded version of a system, subsystem, or component (which can be hardware, software, or a combination of both).

**Reliability**

Probability that a specified software or hardware item performs a given task successfully under specified conditions for a specified length of time or number of cycles.

**Remotely-Operated Vehicle (ROV)**

A remotely operated vehicle is a tethered underwater robot. An ROV may sometimes be called a remotely operated underwater vehicle to distinguish it from remote control vehicles operating on land or in the air. ROVs are unoccupied, highly manoeuvrable and operated by a person at a distance. They are linked to the power and communications source by a tether (sometimes referred to as an umbilical cable), a group of cables that carry electrical power, video and data signals back and forth between the operator and the vehicle.

**Repository**

A facility providing permanent storage, preservation, disposition, and distribution of information about resources, particularly data and their associated metadata.

**Resolution (pertaining to instruments/sensors)**

The smallest amount of input signal change that the instrument/sensor can detect reliably.

**Resolution (pertaining to spatial or temporal characterization requirements)**

The capability to distinguish (i.e., resolve) physical, chemical, or biological features within a specified spatial or temporal interval.

**Resource Reference**

A link, pointer or bookmark that will indicate the location of a resource of interest, without having to copy it.

**Role**

Function to be fulfilled by a particular user. Roles allow granting specific functionality to a certain user or group of users.

## **Sampling**

(1) Physically extract a given volume of the milieu (with bottle, core, pumping,...) in the laboratory or in an in situ analyser. (2) Get a measurement from the milieu.

## **Sampling protocol**

The set of rules used to describe scientific measurement, physical sampling and reporting.

Scale (1) System of grouping or classifying in a series of steps or degrees according to a standard of relative size; (2) According to a hierarchy.

## **Seafloor**

The interface between the bottom of the water column and the upper few meters of solid surface beneath it. The seafloor is sampled by instruments on benthic packages and seafloor packages.

## **Seawater ground**

The return current ground “cathode” for a Primary Node.

## **Seismonument**

A cement housing that hosts a short-period seismometer that provides coupling to the seafloor.

## **Semantic Metadata**

Information characterizing the meaning of an entity (often a data set).

## **Sensor**

A device that will convert a physical phenomenon into an electrical signal that can in turn be digitised through the use of an analog to digital converter. A sensor is normally housed in an instrument. Data coming from sensors is normally raw and needs to be calibrated.

## **Service**

Agreement The legally binding document that describes the service offering to the service user.

## **Service Agreement Proposal**

Request to use a resource together with a proposal of conditions, constraints and parameter ranges. Part of the negotiation process. For instance, the request to use a specific sensor in a certain time interval once an hour for 1 minute, along with its associated bandwidth and impact on the environment.

## **Service Network**

A group of interdependent services covering a specific topic (such as Sensing and Acquisition) that will be implemented as a subsystem.

## **Serviceable Design Life**

The period of time commencing from the date of the Final Acceptance that the System is designed to operate in conformance with the Specifications with proper maintenance.

## **Shallow Profiler**

A profiler used to profile the water column from 150-200 m below the sea-surface to just below the sea-surface.

## **Shore Station**

Physical structure housing the marine infrastructure termination and support equipment that interfaces to terrestrial infrastructure (internet and power).

## **Site**

Geographic domain of interest within an array occupied by a collection of physical instances of nodes and/or platforms together with their instruments and sensors. Examples: Hydrate Ridge, Pioneer Central Surface Mooring, Mobile Assets operating within an Array.



## **Software Application**

A computer program that performs the transformation of an input into an output.

## **Software Component Package**

Entity that wraps and describes a software component. Packages can depend on other packages. A package has a unique name and a version. Packages can be stored in a repository.

## **Spot measurement**

A single measurement in time for which an instrument samples only for the time it takes to record the measurement. This is different from instruments that need to average data for some time period before acquiring a valid measurement. An example of a spot measurement is a water temperature measurement in which the temperature probe is always immersed.

## **Standalone observatory**

Non cabled infrastructure

### **Standalone acoustic observatory (SAAO)**

Observatory in which the observation data are typically transmitted from the seabed to the users thanks to an acoustic modem. The receiver can be placed either on a ship for occasional transmissions or on relay-buoy towards a permanent data server on shore.

The main limit of such architectures lies in the modest amount of data they can transmit between two maintenance interventions on the seabed.

### **Standalone winch observatory (SAWO)**

In a SAWO design, a winch allows a float equipped with satellite transmission system to reach the sea surface to transmit data. This float is immersed when the sea is ice covered or too rough.

## **State**

A property of a resource that persists over time.

**Steady-State**

Continuous demonstrative behavior of the system within the limits or range of the requirements.

**Storage Resource**

Physical or virtual unit for arbitrary data storage and retrieval. Can be a network file system, a distributed database, or a read-only data-warehouse interface. Operational units can make use of many storage resources.

**Stretch hose**

A mooring element comprised of high strength hose, typically encasing spiral wrapped conductors and (optionally) optical fibres. Can stretch upwards of 200% of original length while maintaining electrical and optical continuity.

**Submersible**

Short range non-military submarine.

**Subscribe**

Arrange for access to an on-line service; request direct provision of a particular type of information, for example a particular stream of data.

**Sub-seafloor**

First layer of the earth crust or sediment situated under the sea. It is applied to depth reachable without specialized drilling vessel.

**Subsystem**

Implementation and integration unit for all services of a services network together with their data models and user interfaces.

## **Support**

(1) Provide basic physical infrastructure to which things can be added or appended without replacement of the infrastructure; (2) Enable to function or act, does not specifically inhibit or exclude future capability or modification; (3) Provide assistance to people or systems that require it.

## **Survive**

Experience an event without major loss of hardware. System may experience loss of functionality requiring repair to return to normal mode functionality. Also see "operate" and "sustain". An example would be Solar panels blown out in a 50 year storm, the mooring remains on station and continues to operate on battery power with reduced sampling and telemetry.

## **Sustain**

Experience an event (environmental extreme or condition) without permanent loss of normal mode functionality. System may experience reduction of functionality during event. Also see "operate" and "survive". Example: Profiler parks on bottom during 25 year storm.

## **System**

A collection of interacting components designed to satisfy a set of requirements.

## **System Design Life**

The period of time commencing from the date of the Final Acceptance that the System is designed to operate in conformance with the Specifications without the need to replace key elements.

## **Technical Environment**

Technologies, interfaces and frameworks required to deploy and instantiate a node in the network. Part of the technical environment is the specification of how to interact with operational units of nodes for monitoring and management purposes.

## **Technical Performance Measure**

Technical Performance Measure (TPM) is a formal method of measuring the technical performance of the system design that is implemented and used during the entire course of

the program. TPM enables early assessment of technical risks associated with meeting system requirements. The TPM methodology includes four steps: (1) Identification of requirement to measure; (2) Definition of TPM parameters; (3) Selection of critical parameters; (4) Monitor and assessment of parameter values.

### **Test Procedure**

The detailed instructions for the setup, execution, and evaluation of results for a given verification procedure.

### **Threshold**

As used in TPM, the limiting acceptable value of a technical parameter; usually a contractual performance requirement.

### **Tilt**

A measurement of inflation, deflation or faulting as recorded by changes in the angle of topographic relief as measured in degrees.

### **Time Stamping**

Process of associating time with measurement.

### **Tolerance Band**

Management alert limits placed each side of the planned profile to indicate the envelope or degree of variation allowed. The tolerance band represents the projected level of estimating error. Used in TPM.

### **Transducer**

Collective term for sensors and actuators.

### **Usability**

Usability measures the quality of a user's experience when interacting with a product or system whether a Web site, a software application, mobile technology, or any user-operated

device. In general, it refers to how well users can learn and use a product to achieve their goals and how satisfied they are with that process (US HHS 2006; <http://www.usability.gov/>).

## **Use**

Employ an entity or resource for some purpose.

## **User**

A user is an agent (human or software) that will consume and optionally act upon the infrastructure. A user belongs to a user class.

## **User Class**

Defines the role of a user from which privileges of the user can be derived. User Identity The collective set of user credentials by which a user can be identified or authorized.

## **Validation**

Confirms that the product, as defined, will fulfil its intended use.

## **Variation**

As used in TPM, the difference between the planned value of the technical parameter and the achievement-to-date value derived from analysis, test, or demonstration.

## **VDSL2**

Very-high-speed digital subscriber line 2 (VDSL2 - ITU-T G.993.2) is an access technology that exploits the existing infrastructure of copper wires (twisted pairs).

## **Verification**

Confirms that work products properly reflect the requirements specified for them. In other words, verification ensures that “you built it right.”

**Virtual Environment**

An environment that is partially or totally based on computer generated sensory inputs. (<http://www.fas.org/spp/military/docops/usaf/2020/app-v.htm>).

**Virtual Local Area Network**

A group of hosts (i.e., network ports) that communicate as if they

**Virtual Observatory**

The network of inter-operable representations of observatories.

**Virtual Participation**

Participation in an online rather than onsite venue.

**Visualization**

The depiction of information in a graphical form to aid in its understanding. May include multiple sources or types of information, geographic (2-D), geospatial (3-D), temporal, or geo-spatio-temporal (4-D) representations of information.

**Waypoints**

Specific locations used to define the path of a vehicle. Waypoints are typically defined by latitude-longitude pairs or range and angle offsets from another waypoint, and may include depth.

**Web Client**

An application that can use HTTP (and related protocols) to receive documents written in HTML (and potentially extended languages) from a web server and present those documents to a user.

**Web Server**

A networked computer and software that can receive HTTP (and related protocols) requests

and return HTML documents.

### **Web Tools**

Tools that reside on the internet and allow FixO3 education providers and users to manipulate FixO3 data, models and other resources.

### **Web-based**

Information and/or an application made available via the World Wide Web and requiring a web-browser for access (see <http://techcollab.csUMB.edu/techsheet2.1/glossary.html>).

### **Well-coupled**

To obtain high resolution seismic measurements, sensors are either buried in sediments in a caisson (broadband measurements) filled with silica beads or placed in drill holes in basaltic substrate or in seismonuments. This allows direct contact of the sensor to the seafloor (coupling) and an acoustically quiet environment in terms of anthropogenic “noise” and that from currents.

### **Wet-mateable connector**

Electrical and/or fiber-optic connector that can be mate/de-mated under water, at depth, by a ROV.

### **Wire-Following Profiler**

A profiler that ascends and descends along a mooring wire segment.

### **Workflow**

Sequence of work steps in a complex structure. Workflows can be pre-programmed or static, can have dynamic decision points, or can be composed dynamically.

### **Workstation**

Computer to run Element or Observatory Management System software.

## Appendix B. Observatory Instrument Data Sheet

An example of instrument datasheet is proposed hereunder. This description will be used also for the ongoing discussions inside FixO3 for the sensor registry and Yellow Pages activities.

Device description		Device Picture
<b>Manufacturer:</b>		
<b>Model:</b>		
<b>Serial Number:</b>		
<b>Description:</b>		

Contact	
<b>Property of:</b>	
<b>Contact person:</b>	
<b>E-mail:</b>	
<b>Phone:</b>	

<b>Purchasing / rental or cession information</b>
---



<b>Receiving date</b>	
<b>First commissioning</b>	
<b>Condition</b>	New acquisition Indefinite free cession On rental Yielded for one project Other
<b>Project</b>	FixO3 – xxx
<b>Instrument value</b>	€

<b>Instrument Location</b>	
Shore Station	<input type="radio"/>
Buoy	
Meteorological Instrument (emerged)	<input type="radio"/>
Oceanographic Instrument (submerged)	<input type="radio"/>
Seabed Station	
Cabled Instrument	<input checked="" type="radio"/>
Autonomous Instrument	<input type="radio"/>

<b>Installation specs</b>	
Position / orientation	
Free space around or distance to other objects	
Possible interferences with other instruments	

<b>Maintenance periods</b>	
Visual Inspection	Every 4-8 weeks
On site soft cleaning	Every 4-8 weeks
Deep cleaning in the lab	Every year
Calibration	Every two years

<b>Technical information</b>
------------------------------

1- Measurement variables

Variable	Units	Precision	Resolution
Temperature	°C	0.001	0.0001

2- Dimensions of Instrument (net)

Weight [Kg]	
Height	
Width	
Depth	

3- Packaging (Brut)

Weight [Kg]	
Height	
Width	
Depth	

4- Electrical requirements

Supply voltage [V] (min/nom/max)	12V
Max and average current [A]	0.05 / 0.5 A
Energy per day [WH/d]	

5- Data Interface

Type (serial, ethernet, other)	
--------------------------------	--

Baudrate	
Average data per day	
Server requirements / storage	

6- Electrical interface

Connector model	
Pin out	

7- OBSEA connection cable

OBSEA		S/E Converter		Instrument	
Connector GISMA series 10 size 3 - 7 pins female	Falmat Cable FM022208- 01K12	Board with serial to Ethernet Converter Moxa NE4120S		Seacon Cable	Seacon Connector MC-IL 8F
1 +12V	White 14AWG	OP1 (+12V)	CTD5 (+12V)	Red	3 Power +
2 GND	Shield	OP2 (GND)	CTD1 (GND)	Green	4 GND
3 Rx- [Dio1]	Green	Et1 (Rx-)		Blue	6
4 Rx+ [Dio0]	Wh/Green	Et2 (Rx+)		Orange	5

5 Tx- [S_Rx]	Orange	Et4 (Tx-)	CTD2 (Tx)	White	2 RS 232 Tx
6 Tx+ [S_Tx]	Wh/Orange	Et5 (Tx+)	CTD4 (Rx)	Black	1 RS 232 Rx
7 Return	Black 14AWG	OP3 (AI)		Red/Black	8
				Wh/Black	7

**Calibration certificates**

**Working Periods**

**Observations**

**Incidences**

## Appendix C Materials

This paragraph is an update of the corresponding chapter in Esonet label document<sup>vii</sup>.

**The underwater equipment must be constituted of sub-systems isolated between each other. The corrosion protection of each subsystem must be ensured with one principle (cathodic protection or validated corrosion compatibility).**

**Isolators** between systems with independent cathodic protection is mandatory. The quality of isolation must be checked before deployment. Some pieces of equipment will impose their material choice. In any case these pieces should be isolated. Electrical mass link through cables might endanger this isolation. This must be dealt with on a case-by-case principle.

Review of materials used in service deep sea applications:

**Steel** with cathodic protection is the standard solution, usually anodes made in Zinc alloy. Rules of the offshore industry may be applied. The control and exchange of anodes will represent a maintenance cost that must be accounted for in the operating costs.

**Stainless steel:** Common stainless steel (ie AISI 304) is liable of cavernous corrosion and must be prohibited. AISI 316L and AISI 316L Ti may be used with care in some non security components. In any case they must be associated with cathodic protection (mandatory).

**High corrosion resistance alloy:** Several grades of high cost alloys such as nickel based are available and constitute safe solutions: Inconel 625, Hastelloy C22, Super duplex...

**Titanium alloys:** They have been one of the technical enhancement allowing deep underwater intervention. Their extensive use is limited by the cost. Alloys in alpha-beta phase such as 6% Aluminium and 4% Vanadium (or equivalent Russian grades) are a reliable solution.

**Unalloyed titanium** (T40) is used when the mechanical requirements are not stringent. Keep in mind that high performance of titanium alloys have electrochemical potential which may be detrimental to other metals. It is suggested to protect it by painting for instance to limit its active surface.

**Bronze.** Among copper alloys, some have a good behaviour for long time exposure to seawater. They may have the advantage of intrinsic biofouling protection by release of copper ions when they are not cathodically protected.

**Aluminium alloys** of several kinds are a solution for underwater components. The ANSI serie 5000 is not prone to heavy corrosion and may be used with simple anodizing or unprotected (<4 years). The powder produced by corrosion may be a disturbance for some very precise measurements of particles in the abyss. The ANSI 6000 serie and to some extent ANSI 7000 serie (with better mechanical performances) are used with hard anodizing specified for marine application (<4 years). A cathodic protection with **Aluminium-Indium alloys** anodes is ensuring long term endurance.

On sensor heads, small surfaces of **noble materials** (gold, platinum...) are welcome.

### ***Non metallic materials***

For polymer and composite materials good knowledge of behavior in water has to be considered in order to limit the risk of long-term detrimental degradation processes (hydrolysis, etc.). However, it must be noted that degradation of such material is generally

thermally activated and except in really specific areas (black smokers, etc.), temperature is low enough (around 4°C) to avoid initiation of degradation processes.

An approach based on accelerated test using time-temperature equivalence can be used to predict long-term performance of polymeric materials however good knowledge of degradation phenomena is needed in order to guarantee pertinence of the accelerated test.

For specific materials as syntactic foam, synthetic fiber for mooring cable, knowledge of long-term behavior has already been addressed through specific program related to offshore industry.

**Thermoplastic materials** have the great advantage to suffer no electrochemical corrosion. Their limitation of use is due to the water ingress and creep. The temperature limit must be checked. Thermoplastics with brittle behaviour (e.g. PVC) are not recommended. Using these materials implies the load is permanent because of the potential creep. PEEK or PCTFE (chlorinated, fluorinated or chlorofluorinated) are a good choice but are quite expensive.

**Polyurethane** is commonly used, but its formula must be especially suited for long term seawater exposure. The polyether type of molecule has acceptable performances. The components of polyurethane and of most thermoplastic materials are changing quite often due to environment regulations and medical regulations for the workers. This may lead to perform again acceptance tests or tests on mechanical characteristics. In general, characteristics for under-water ageing is dependent on the crystalline to amorphous ratio.

### **Composites**

The high mechanical characteristics (tensile and compressive strength) and the possible tuning of elastic matrix characteristics of composite materials in addition to the lack of corrosion are excellent arguments for their use at sea. In long term sea floor deployments, these performances have been demonstrated. In the telecom cable industry, repeaters in glass epoxy have been produced and used for the last twenty years by Alcatel for instance. Components of sensor strings implemented in underwater wells, by industrial companies such as Schlumberger or academic institutes like Ifremer, have shown their cost effectiveness.

In these applications, thick glass epoxy is machined and used as any material.

#### *Resin*

The plastic matrix to be reinforced by fibres must be well tested. The criteria are, as such, a R&D issue in : water ingress, creep, shock, ageing of matrix-fibre interface. The choice of epoxy and vinyl-ester is acceptable. Other matrices such as polyester are not recommended.

The production methods (responsible of the void ratio) and chemical components are changing according to the manufacturer. The qualification is specific, unfortunately existing standards are not sufficient. A good example of methodology was given by the EC project Composite Housing.

#### *Glass fibres*

The reinforcement by glass fibre is providing good performances for the long term. The high glass/matrix ratios are giving better hydrostatic pressure and compressive strength (70 - 80 % in mass). The use of S or R glass for the fibre and the choice of manufacturing method

such as filament winding, fabric pre-preg, injection have been qualified in several design of underwater equipment.

#### *Carbon fibres*

Lighter structures may be designed using carbon fibres. Under tensile or flexural strength design criteria, the additional cost finds good arguments. It is more limited for structures dimensioned by the compressive strength. The feasibility of carbon epoxy pressure hulls has been demonstrated by EC projects. The electrical conductivity of carbon must be taken into account: it is not an isolator.

#### *Syntactic foam*

A composite material made up with very small hollow glass spheres inside a plastic matrix is able to provide buoyant material. It has been qualified for full water depth floats as well as pipe insulation material. The floats must be unitary tested when they are a safety component. They must be preferred to glass spheres.

- Note that functional properties of non-metallic materials must be checked with respect to ageing (for instance, impedance of acoustic transducers may vary).

**Brittle materials** such as glass or ceramics have exceptional compressive strength. But any tensile or shear stress may lead to rupture. They are used for electric insulation in connectors with a very stringent manufacturing process.

*Glass spheres*, although they were the basis of deep ocean exploration in the 20<sup>th</sup> century, are not recommended for ESONET type of long term deployments. Further studies on probability of rupture have been performed by KM3Net project. The distance between spheres to avoid the transmission of implosion was investigated by KM3Net Preparatory Phase (20 m distance for 2000 dbar pressure on 6000 dbar rated spheres is a first recommendation) [19].

---